

SPECIFICATION

- Part No. : **MA413.A.B.003**
- Product Name : MA413 Storm LTE Screw Mount Antenna
- Features : LTE 698-960MHz/1710-2170MHz/
2490-2690MHz Antenna
Screw-Mount [Permanent Mount]
Worldwide 4G Bands including 3G and 2G
Aerodynamic, Super Low-profile Vandal Resistant Housing
IP67 Enclosure
Dims: 216.24*93.25*30.95mm
1M CFD200 with SMA(M) connector
Custom Cables and Connectors Available
Product conforms to the EMC directive 2014/30/EU
RoHS Compliant



1. Introduction

The Storm MA413 antenna is a low profile, heavy-duty, fully IP67 waterproof external M2M antenna for use in worldwide telematics applications which combine Global Cellular communications. The MA413 delivers best in class LTE antenna performance. You will never be out of touch with this extremely robust antenna.

At only 31mm high, the Storm is the world's lowest profile global telematics antenna solution. It delivers powerful worldwide 4G LTE antenna technology while also covering the 3G and 2G bands.

Typical applications:

- Telematics
- HD Video over LTE
- First Responder and Emergency Services
- Intelligent Transport Systems
- Internet of Things (IoT market)
- Wireless LTE M2M Devices
- Digital Signage

LTE 4G applications demand high speed data uplink and downlink. The MA413 does not require a ground plane. Low loss cables are used to keep efficiency high over long cable lengths.

Conformity is declared under the following standard: **EN55022 Class B**

This is to declare that the product listed above conforms to the EMC directive 2014/30/EU.

Cable length and connector types are customizable. Contact your regional Taoglas sales office for support.

2. Specification

4G/3G/2G MIMO1 Antenna									
Frequency (MHz)	LTE700	GSM850	GSM900	DCS	PCS	UMTS1	LTE2600	LTE3500	
	698~803	824~894	880~960	1710~1880	1850~1990	1920~2170	2490~2690	3300~3600	
Efficiency (%)									
On 50*50cm ground plane	30cm	62.06	41.76	49.16	44.93	59.56	59.39	55.42	37.39
	1M	59.27	39.88	46.95	40.98	54.46	54.71	50.55	33.33
	2M	55.31	36.93	42.81	36.86	48.53	48.56	43.53	27.99
	3M	51.62	34.20	39.76	32.65	42.73	42.47	36.84	23.59
	5M	44.25	28.85	33.36	25.50	32.98	32.90	28.22	16.96
In free space	30cm	65.08	48.08	55.44	49.41	57.62	59.92	54.98	38.19
	1M	62.15	45.91	52.95	45.06	52.69	55.18	50.14	34.83
	2M	58.00	42.54	48.29	40.62	46.96	48.99	43.17	29.65
	3M	54.13	39.46	44.80	35.92	41.31	42.84	36.53	24.66
	5M	46.39	33.24	37.60	28.10	31.89	33.19	27.99	19.14
Average Gain(dBi)									
On 50*50cm ground plane	30cm	-2.22	-3.98	-3.20	-3.55	-2.27	-2.27	-2.57	-4.36
	1M	-2.42	-4.18	-3.40	-3.95	-2.66	-2.63	-2.97	-4.86
	2M	-2.72	-4.51	-3.80	-4.40	-3.16	-3.14	-3.62	-5.61
	3M	-3.02	-4.84	-4.13	-4.94	-3.72	-3.73	-4.35	-6.36
	5M	-3.70	-5.58	-4.88	-6.00	-4.84	-4.84	-5.50	-7.79
In free space	30cm	-2.02	-3.19	-2.60	-3.11	-2.42	-2.23	-2.62	-4.25
	1M	-2.22	-3.39	-2.80	-3.51	-2.81	-2.59	-3.02	-4.65
	2M	-2.52	-3.72	-3.20	-3.97	-3.31	-3.10	-3.67	-5.35
	3M	-2.82	-4.05	-3.52	-4.50	-3.86	-3.69	-4.39	-6.15
	5M	-3.50	-4.79	-4.28	-5.57	-4.98	-4.80	-5.55	-7.25
Peak Gain(dBi)									
On 50*50cm ground plane	30cm	5.37	3.66	4.35	6.24	7.04	7.11	7.91	6.46
	1M	5.17	3.46	4.15	5.84	6.64	6.81	7.51	5.96
	2M	4.87	3.06	3.75	5.34	6.14	6.31	6.91	5.16
	3M	4.57	2.76	3.45	4.84	5.64	5.71	6.21	4.46
	5M	3.87	2.06	2.65	3.74	4.44	4.61	5.11	4.82
In free space	30cm	3.54	4.07	4.13	4.67	6.57	6.69	8.11	6.27
	1M	3.34	3.87	3.93	4.27	6.17	6.35	7.71	5.87
	2M	3.04	3.47	3.53	3.77	5.67	5.79	7.11	5.17
	3M	2.74	3.17	3.23	3.27	5.07	5.19	6.41	4.37
	5M	2.04	2.37	2.43	2.17	3.97	4.09	5.31	3.27

Impedance	50Ω
Polarization	Linear
VSWR	< 3
Cable	1 meter CFD200 standard, fully customizable
Connector	SMA Male connector, fully customizable

MECHANICAL	
Antenna Dimensions	216.24*93.25*30.95mm
Casing	ABS+PC
Base and thread	Nickel Plated Aluminum
Weight (including cable)	420g
Ingress Protection Rating	IP67
Maximum Assembly Torque	39.2 N-m
ENVIRONMENTAL	
Operation Temperature	-40°C to 85°C
Storage Temperature	-40°C to 90°C
Humidity	Non-condensing 65°C 95% RH

3. Antenna Characteristics

3.1 LTE Antenna

3.1.1 Test Setup

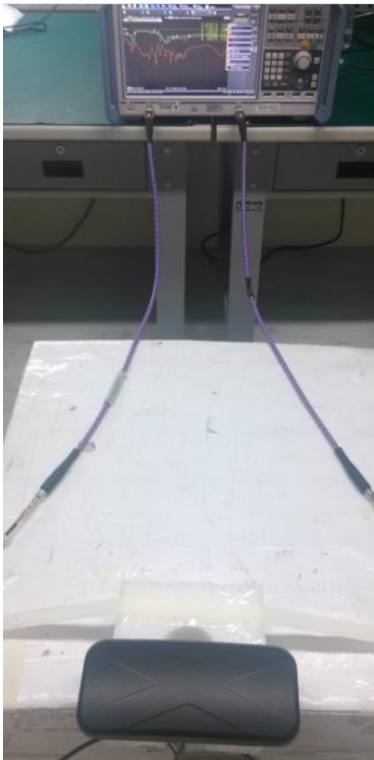

In free space

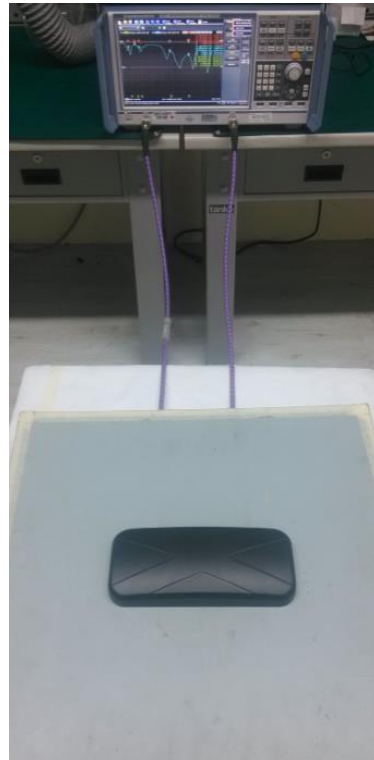

On the 50*50cm ground plane

3.1.2 LTE Antenna Return Loss

Setup on 50*50cm ground plane with 1 meter cable length

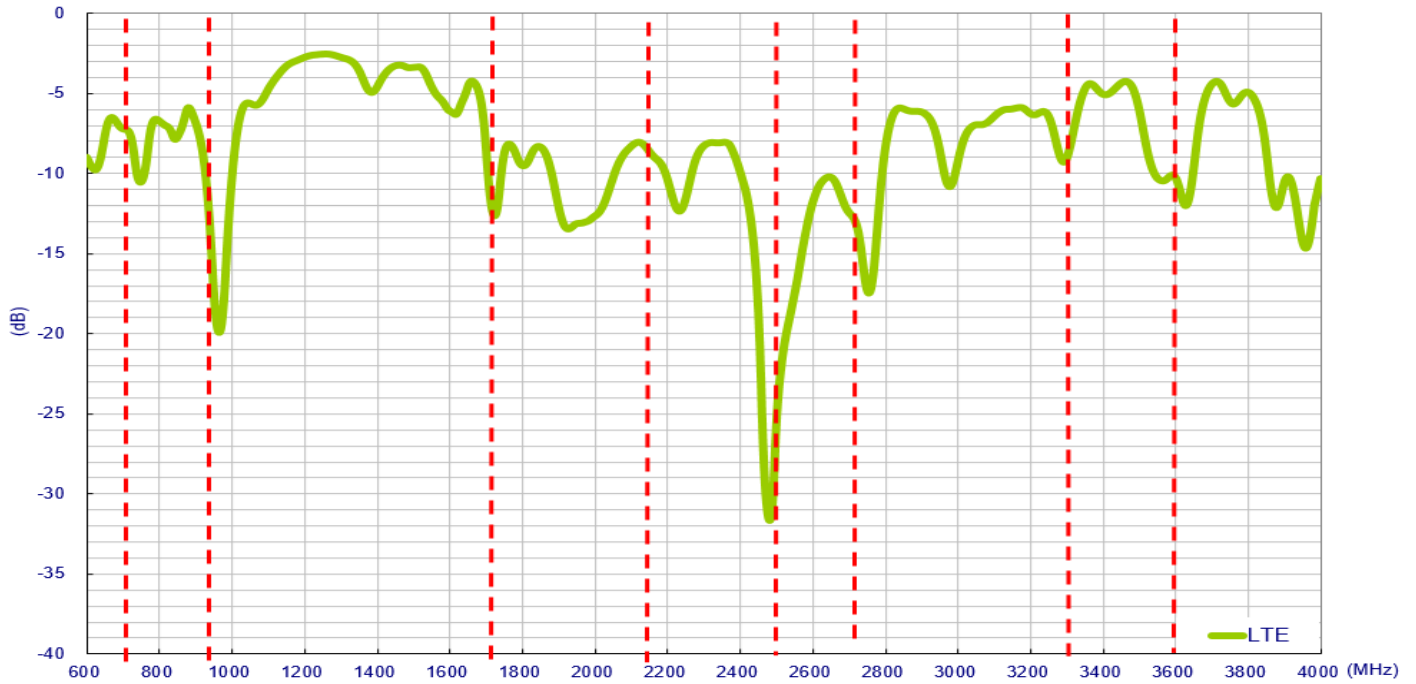

Setup in free space with 1 meter cable length

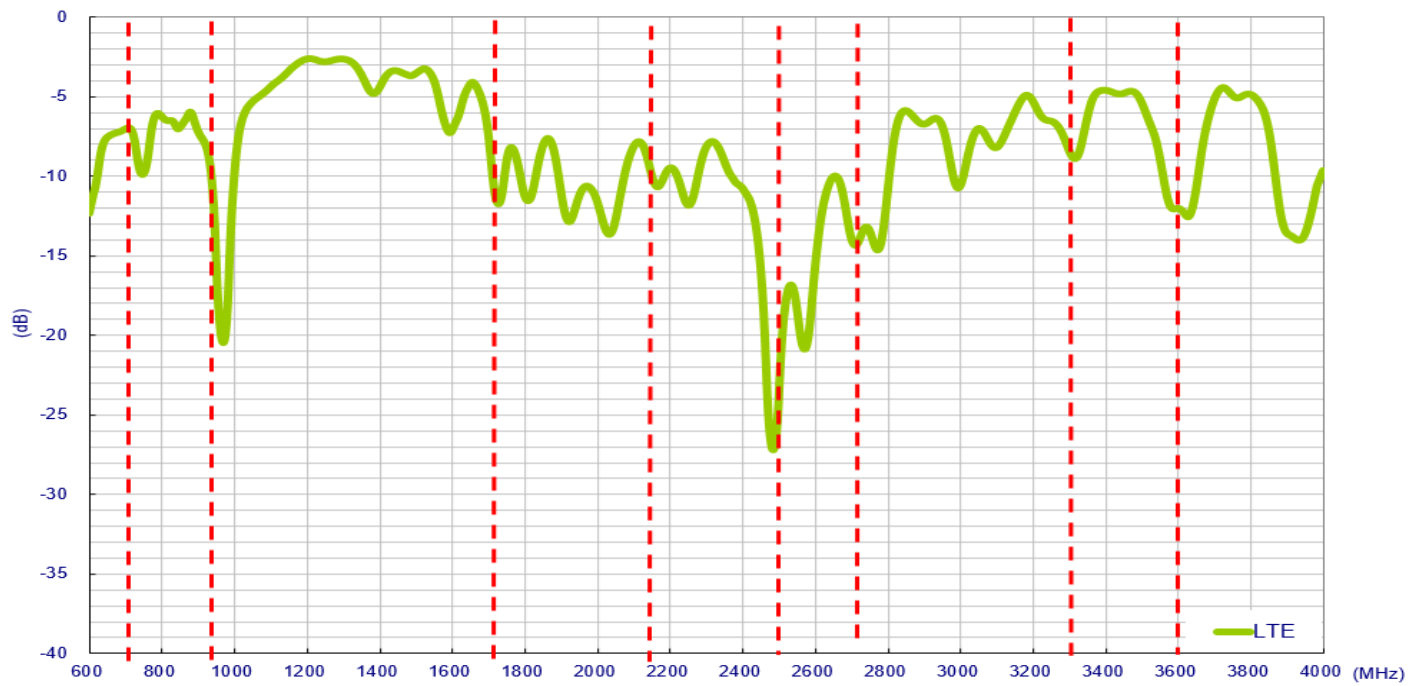

3.1.3 LTE Antenna Efficiency

Setup on 50*50cm ground plane with 1 meter cable length

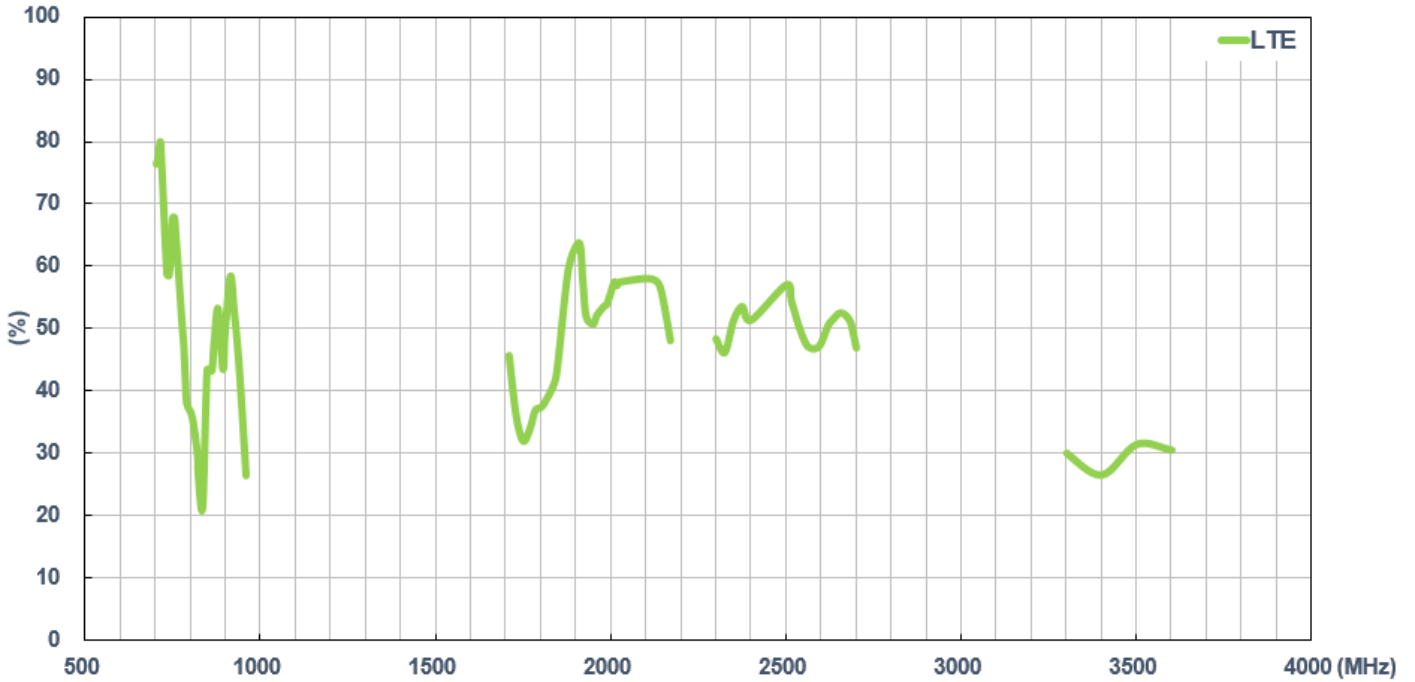

Setup in free space with 1 meter cable length

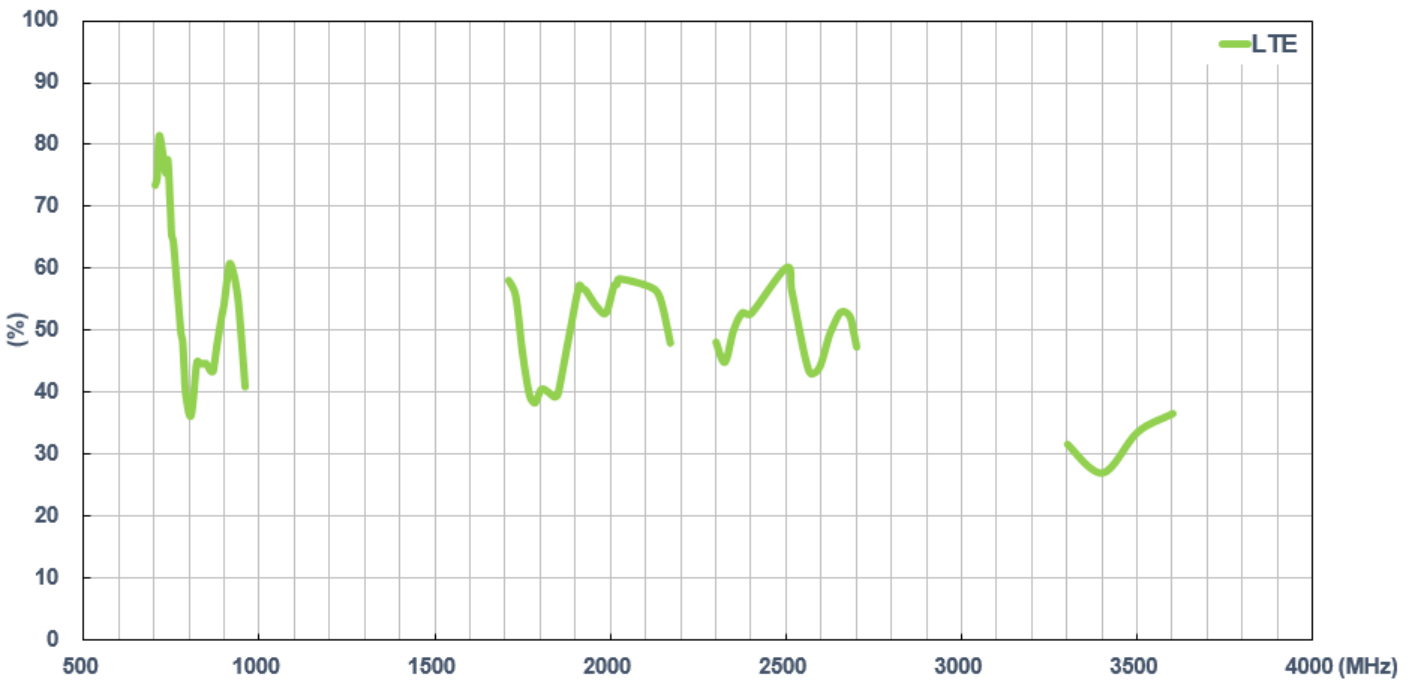

3.1.4 LTE Antenna Peak Gain

Setup on 50*50cm ground plane with 1 meter cable length

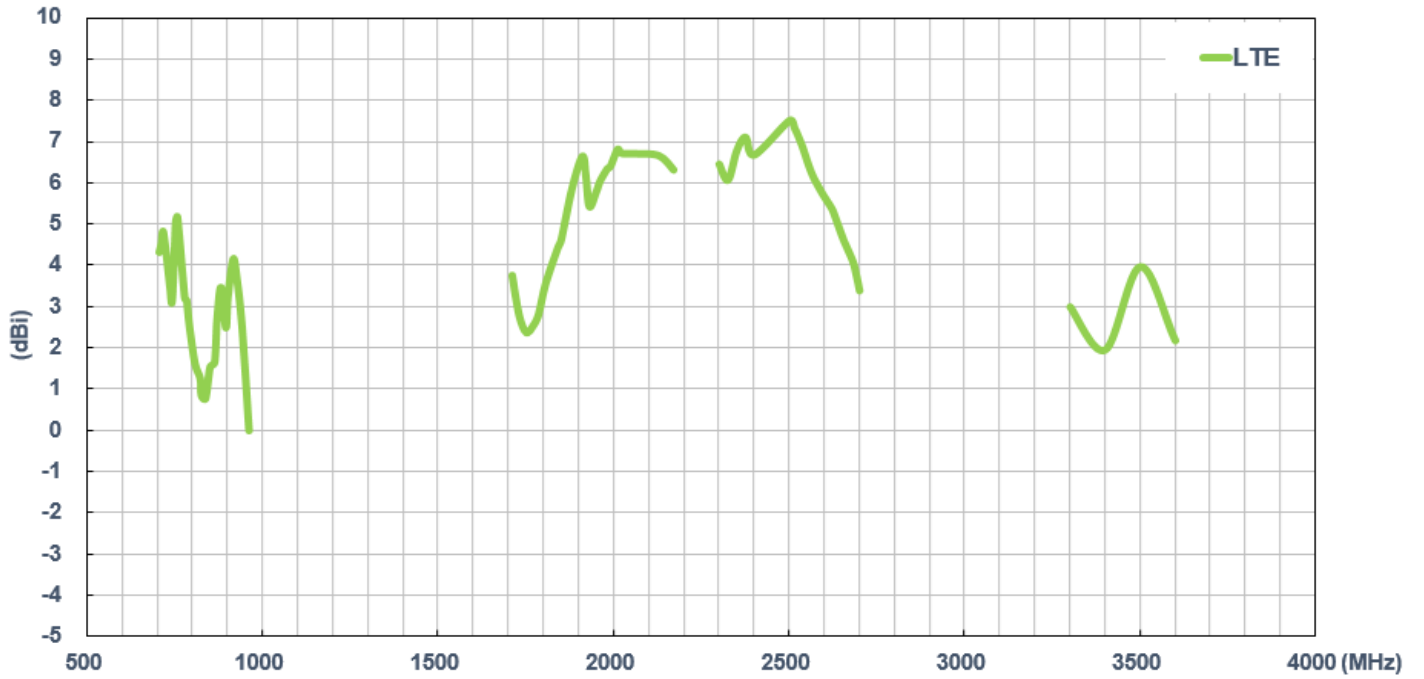

Setup in free space with 1 meter cable length

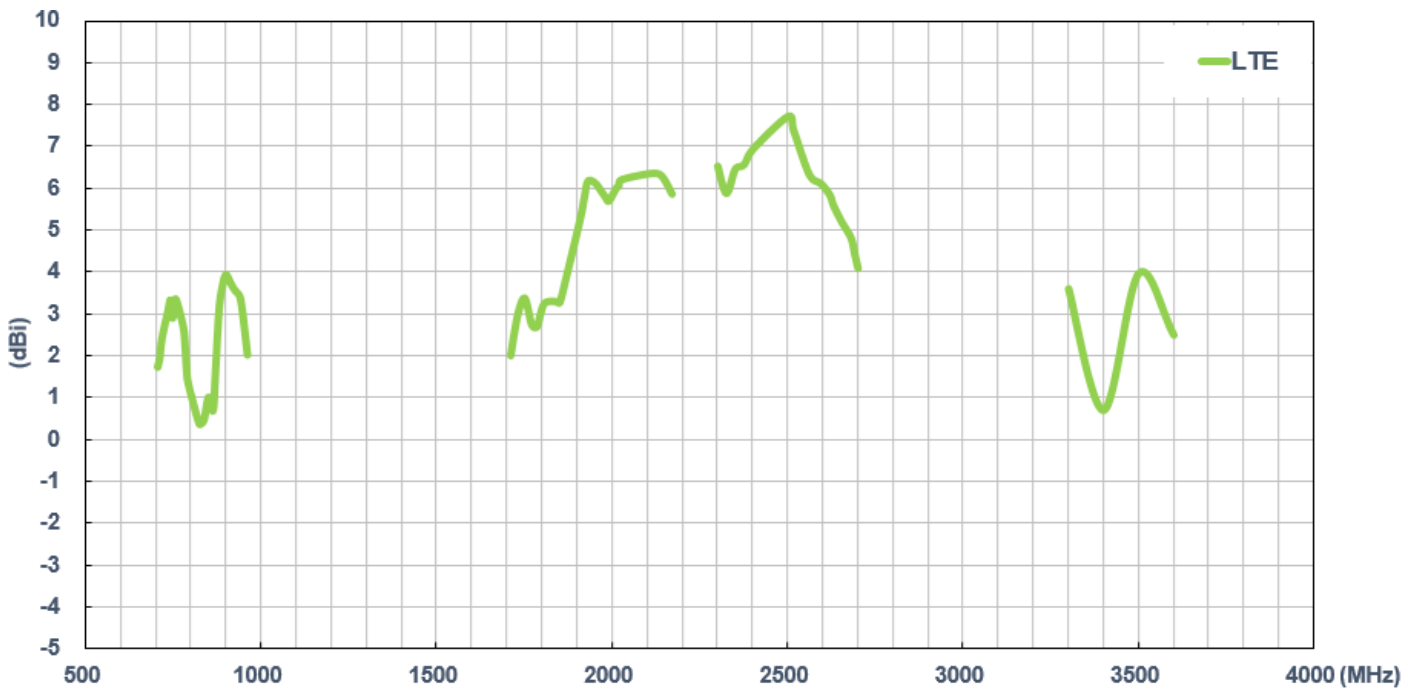

3.1.5 LTE Antenna Average gain

Setup on the 50*50cm ground plane with 1 meter cable length

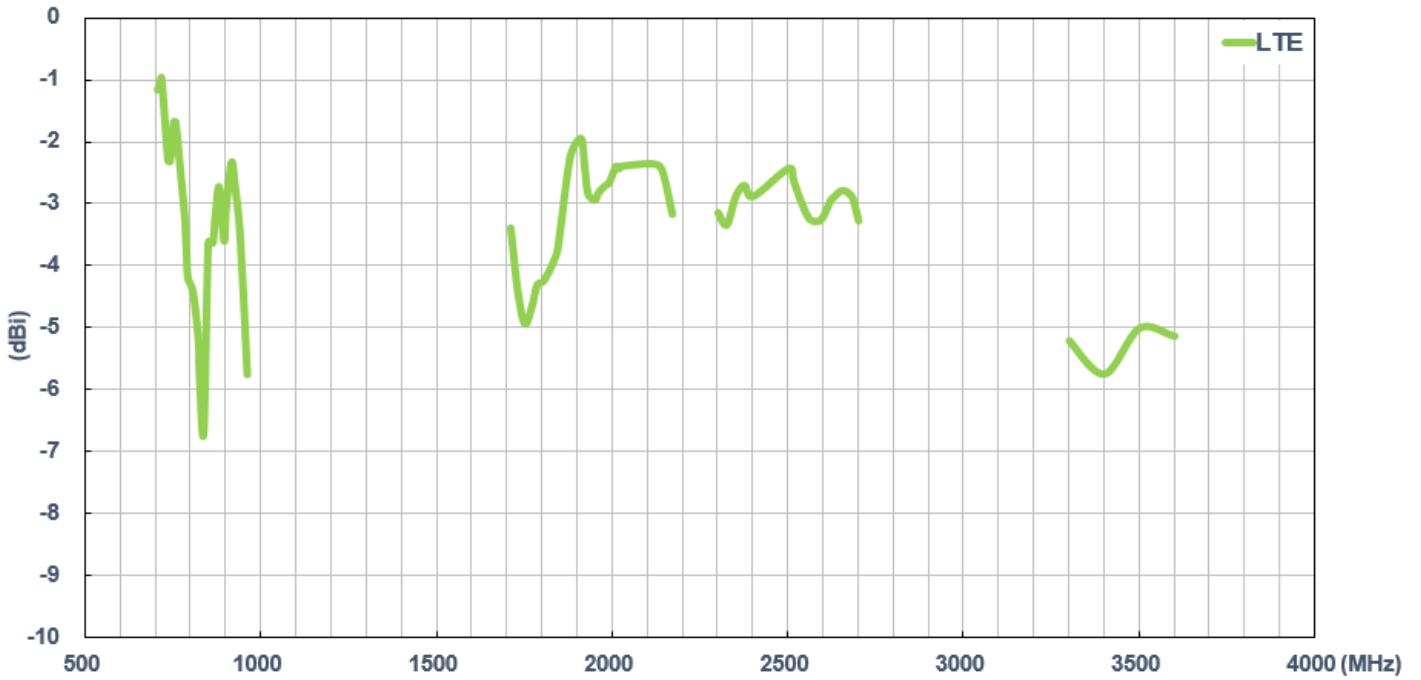

Setup in free space with 1 meter cable length

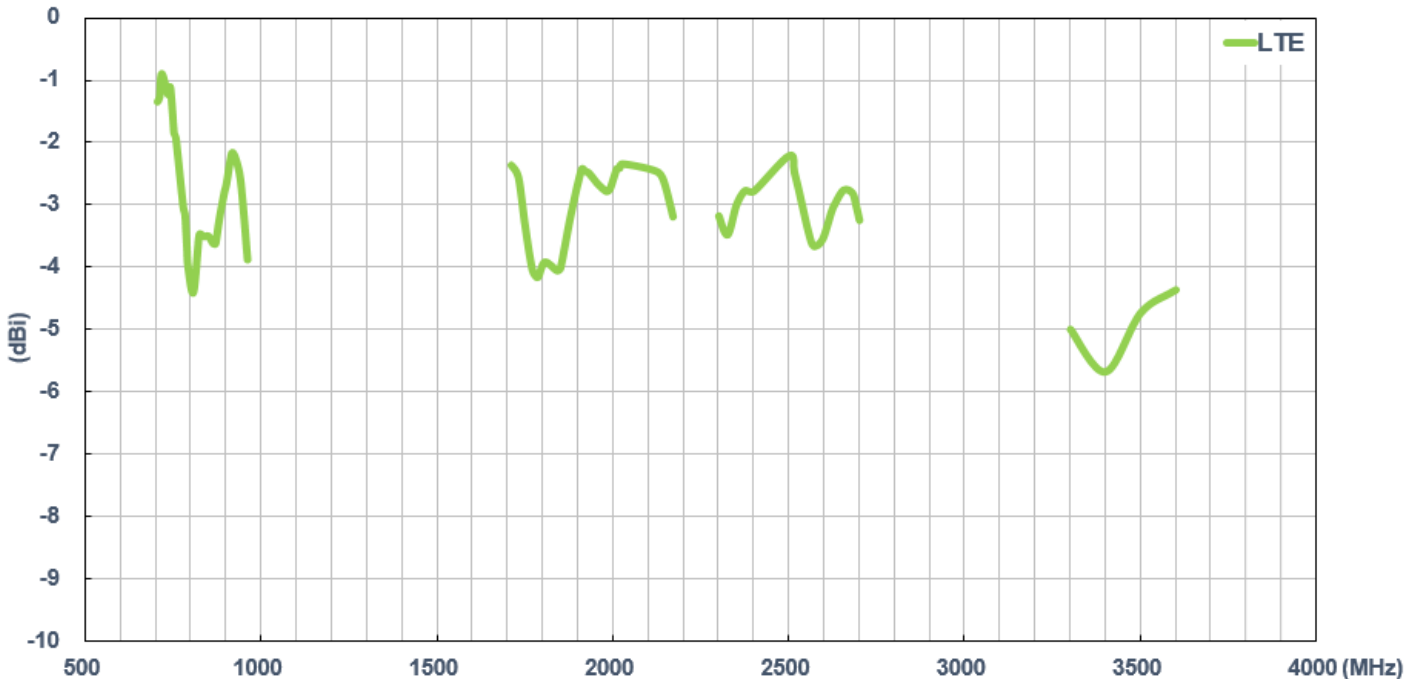

3.1.6 Test Setup for Antenna Radiation Pattern (ETS Anechoic chamber)

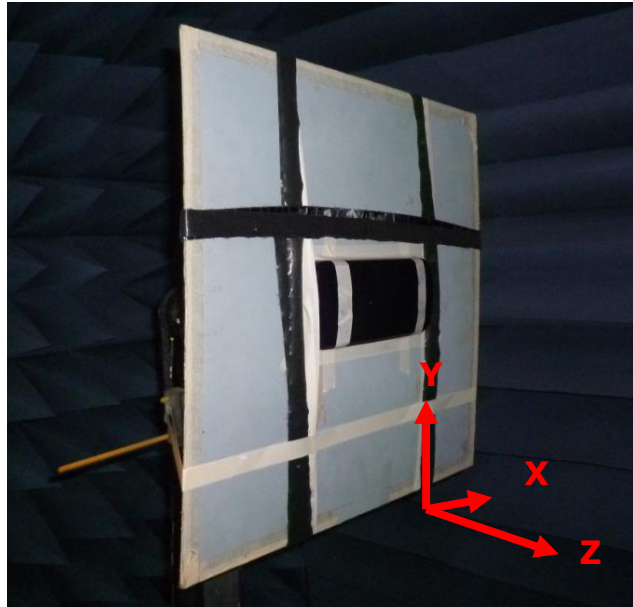

On the 50*50cm ground plane

3.1.7 2D Radiation pattern (LTE with 1M cable length on the 50*50 ground plane)

XY Plane

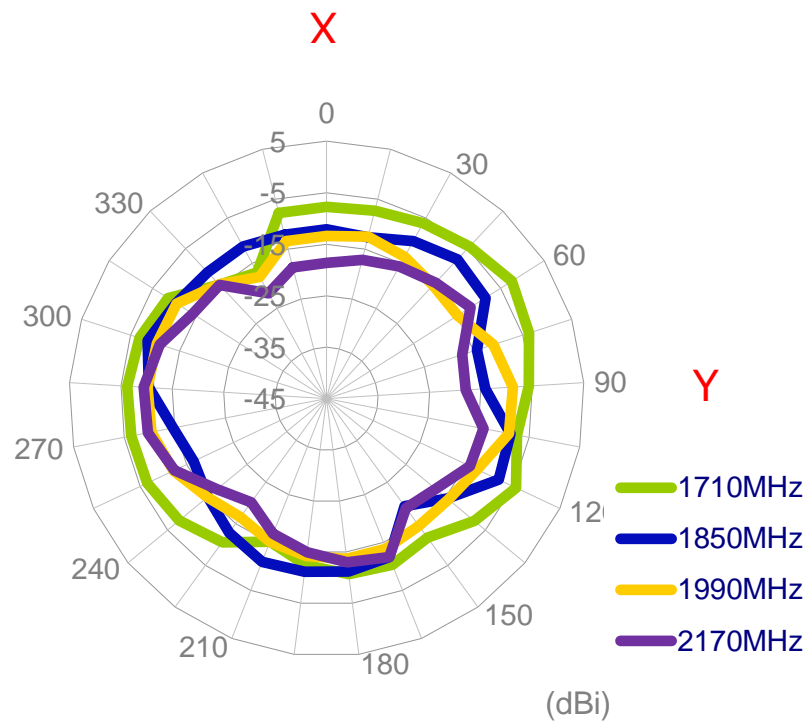
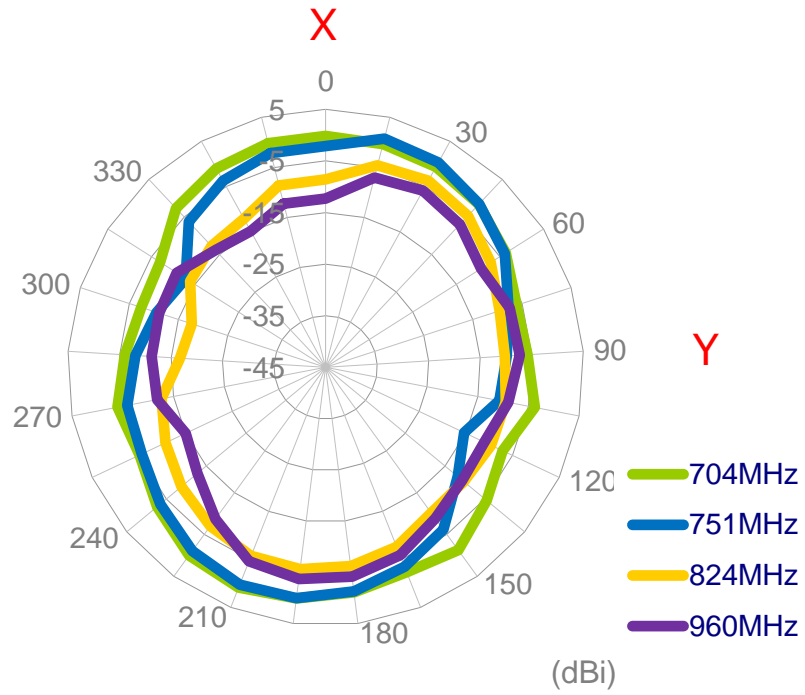

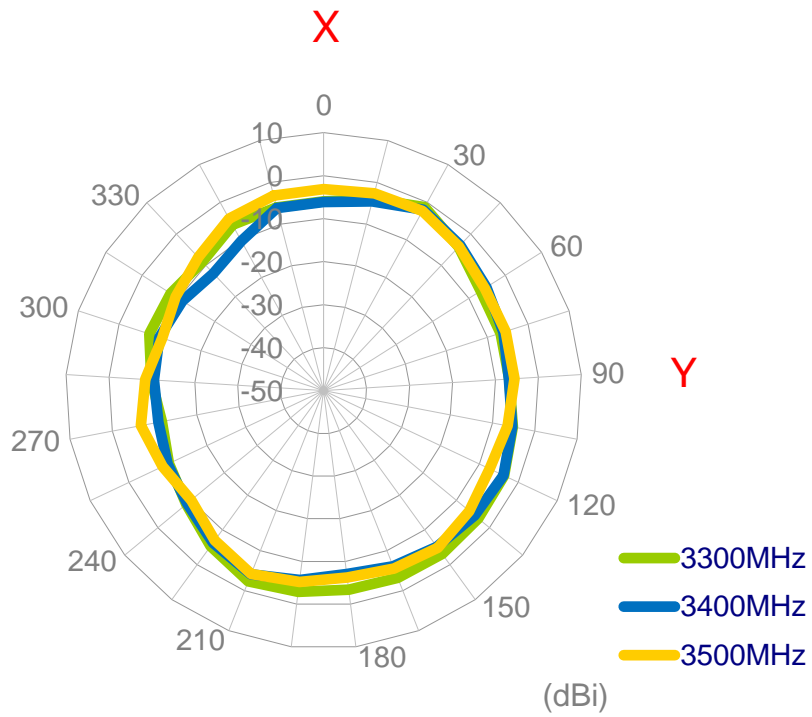
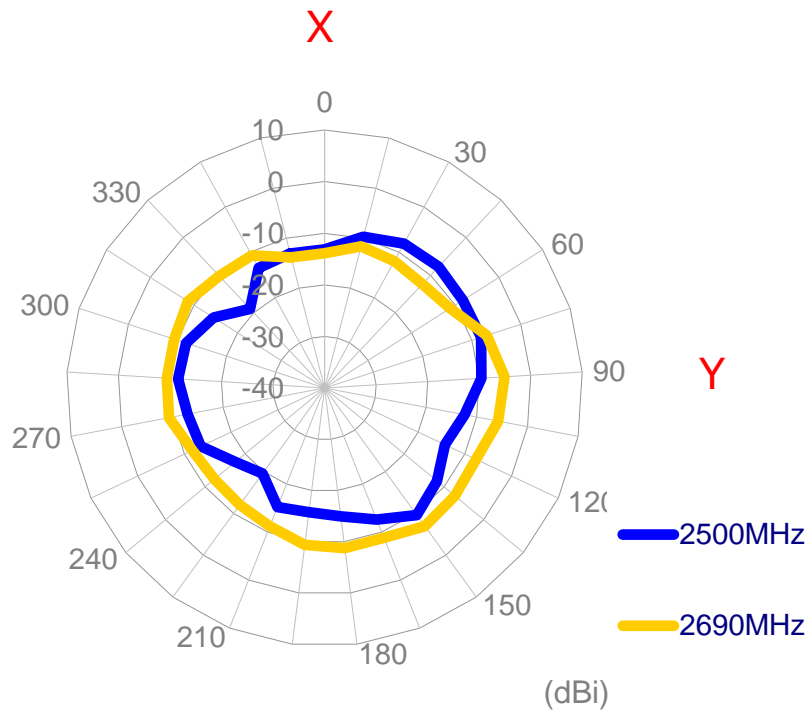

XZ Plane

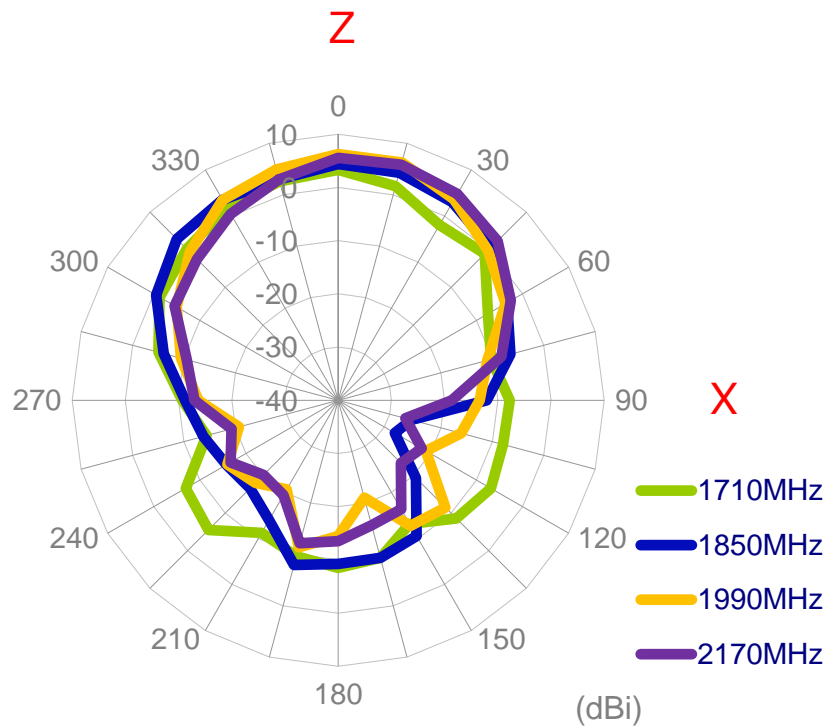
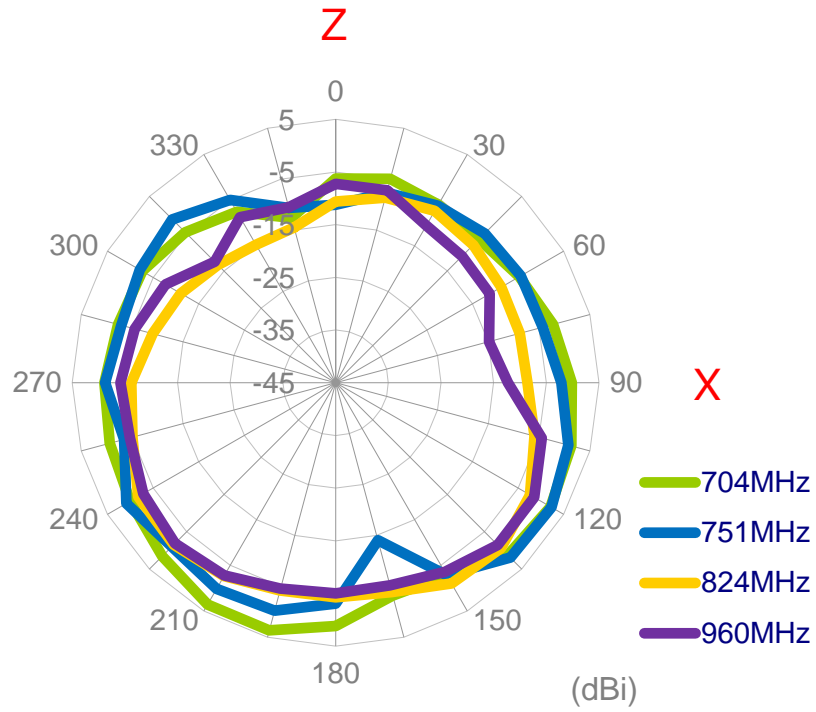

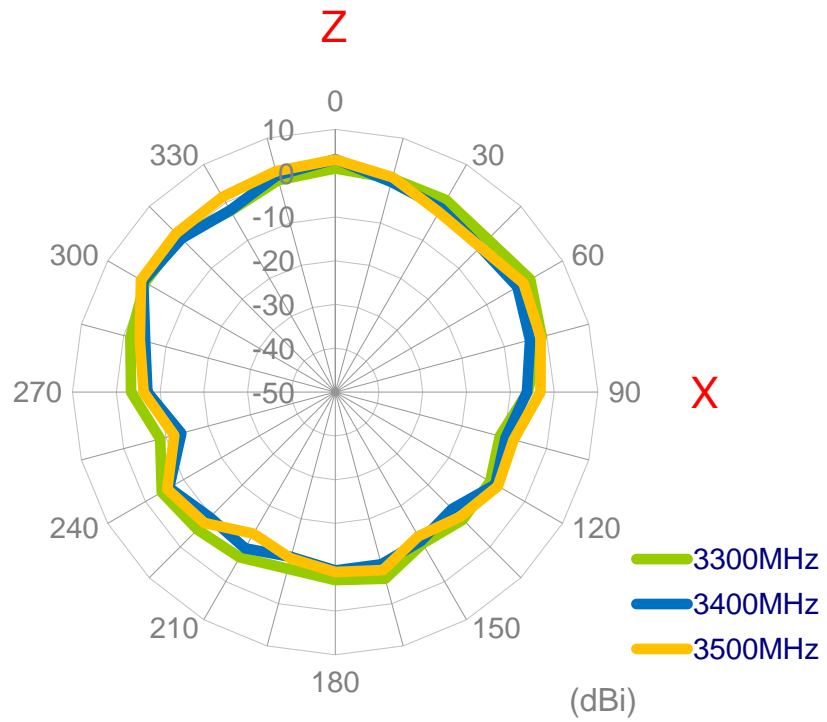
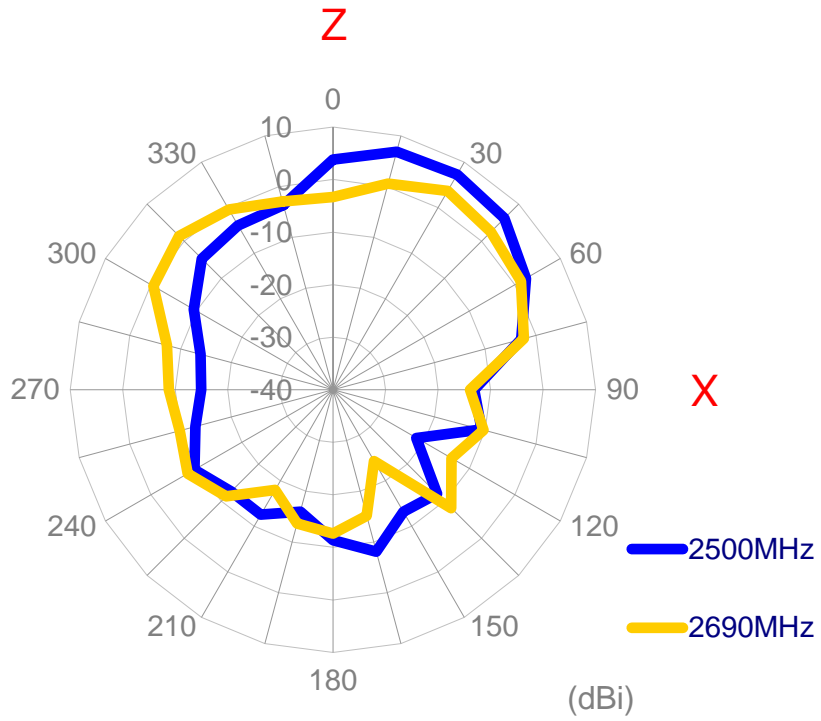

YZ Plane

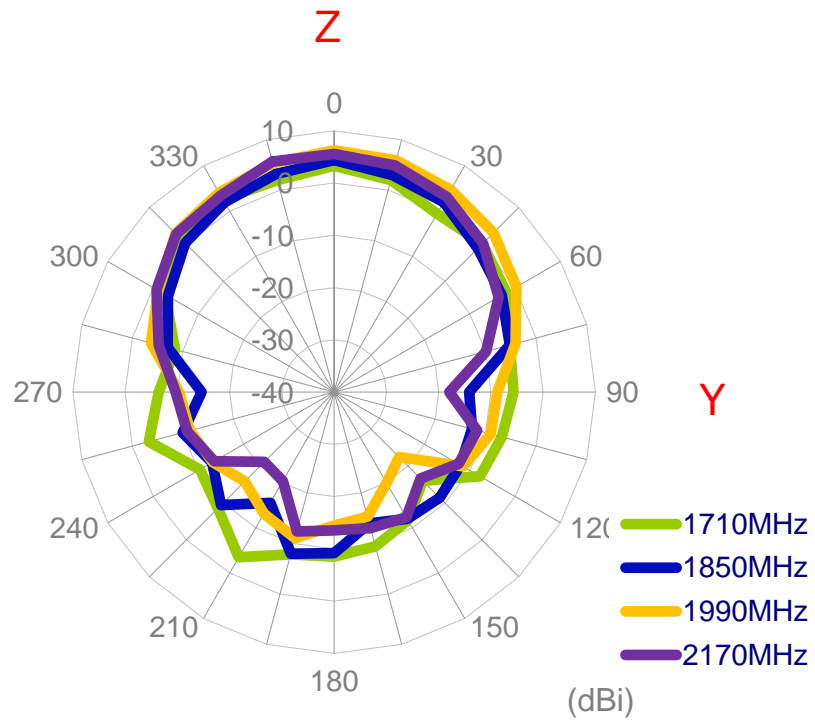
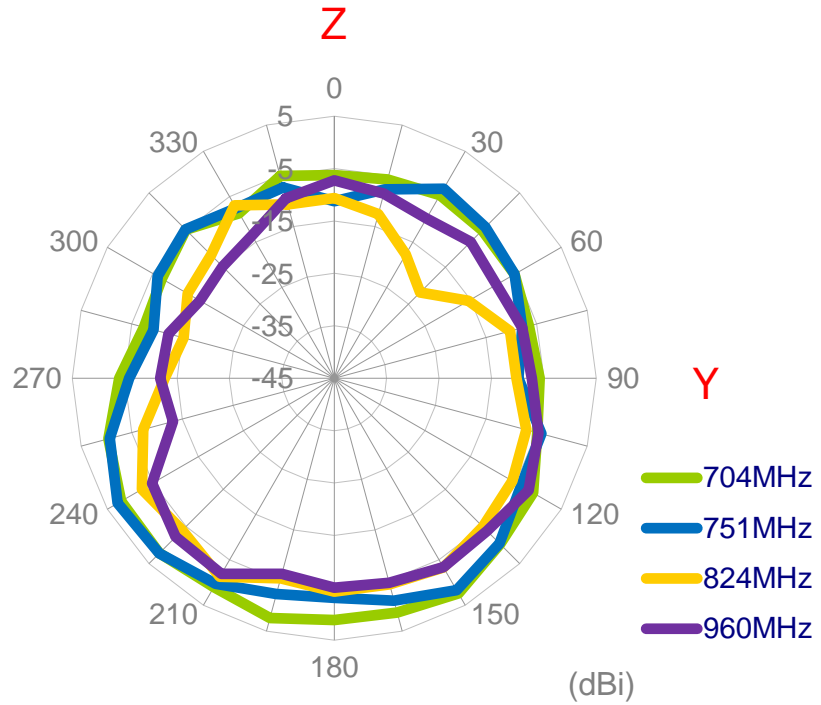

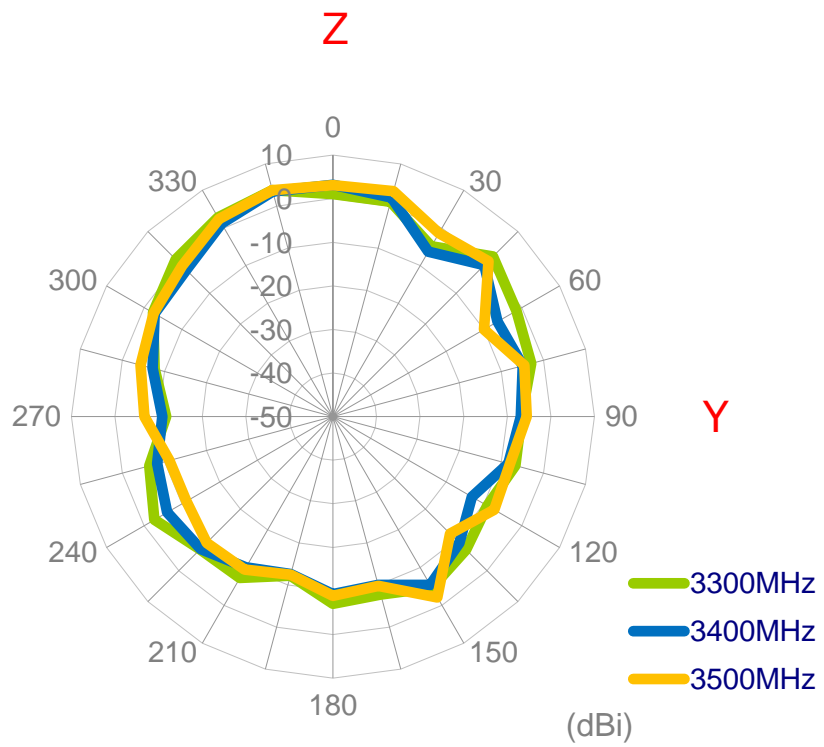
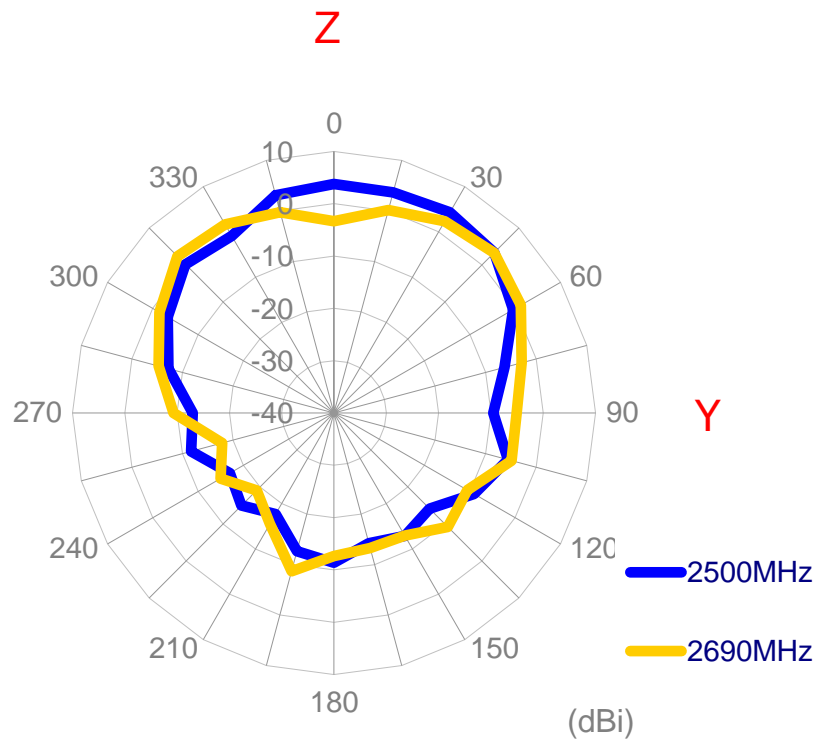

3.1.8 3D Radiation pattern (LTE with 1M cable length on the 50*50 ground plane)

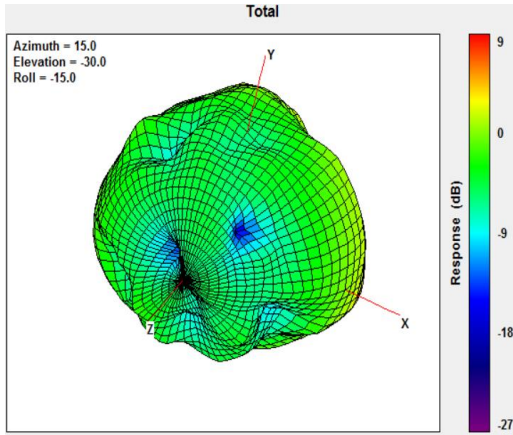

704MHz

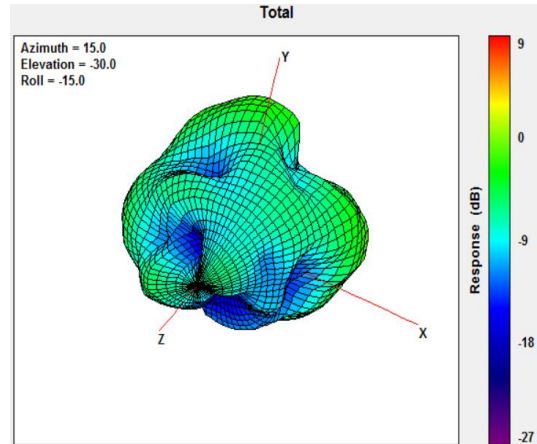

960MHz

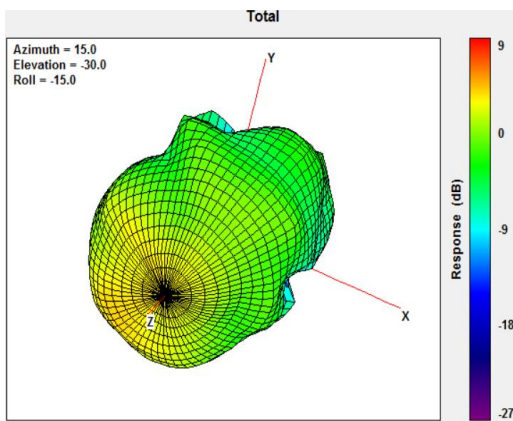

1710MHz

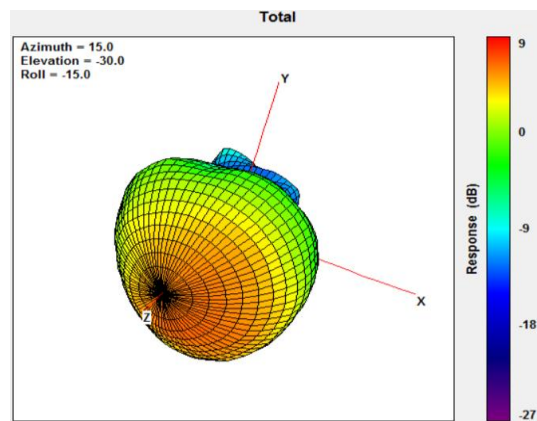

2170MHz

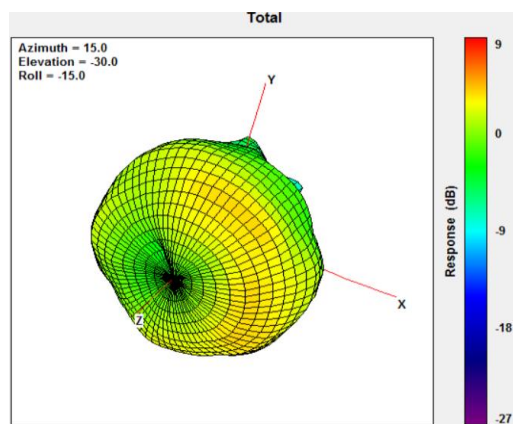

2690MHz

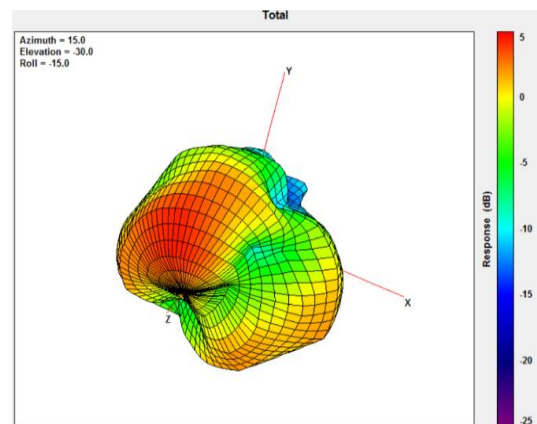

3500MHz

3.1.9 Test Setup For Antenna Radiation Pattern (ETS Anechoic chamber)

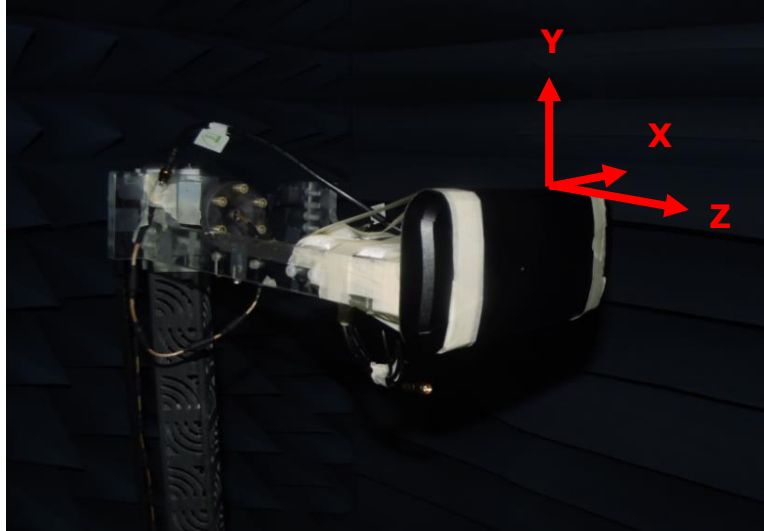

In free space

3.1.10 2D Radiation pattern (LTE with 1M cable length in free space)

XY Plane

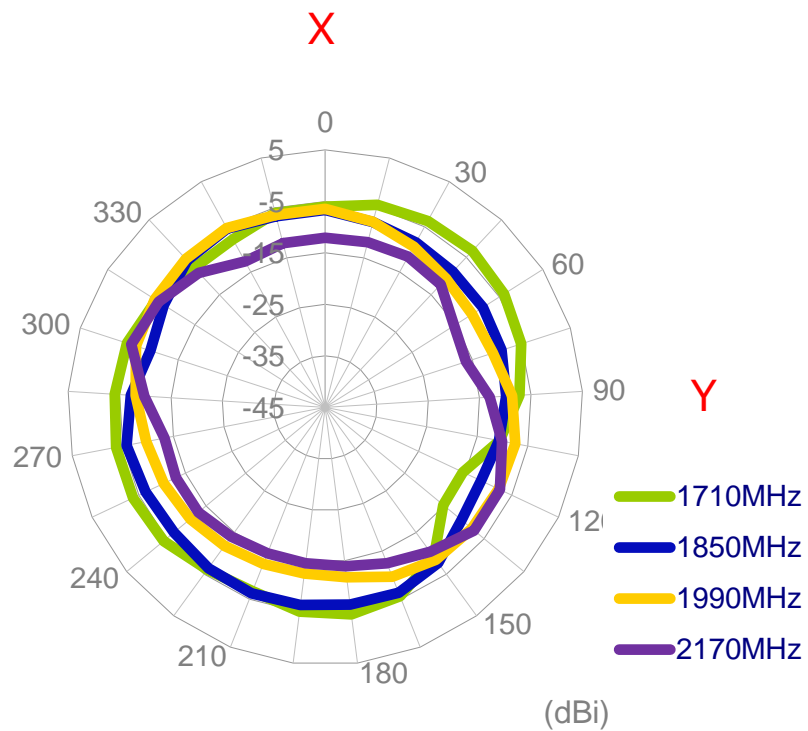
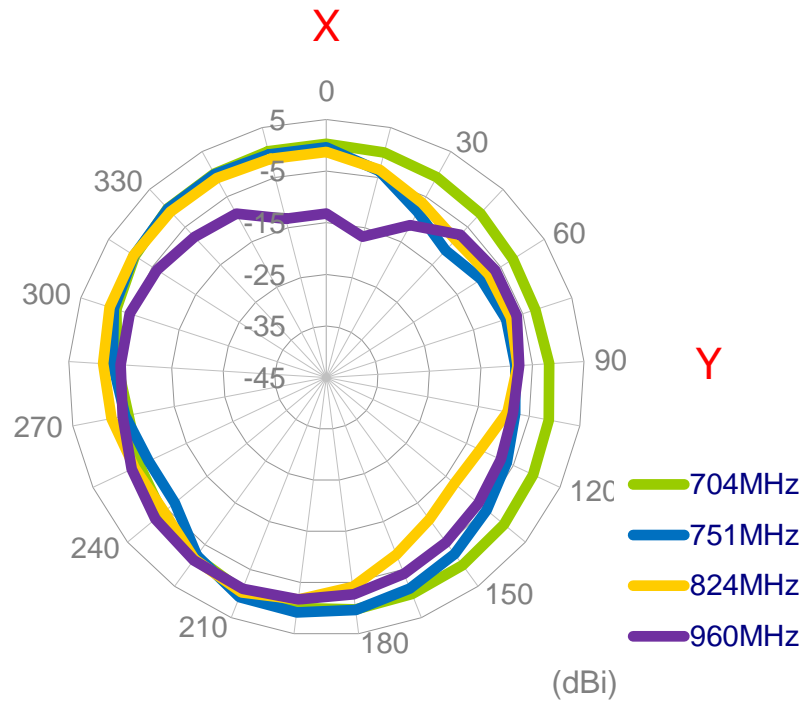

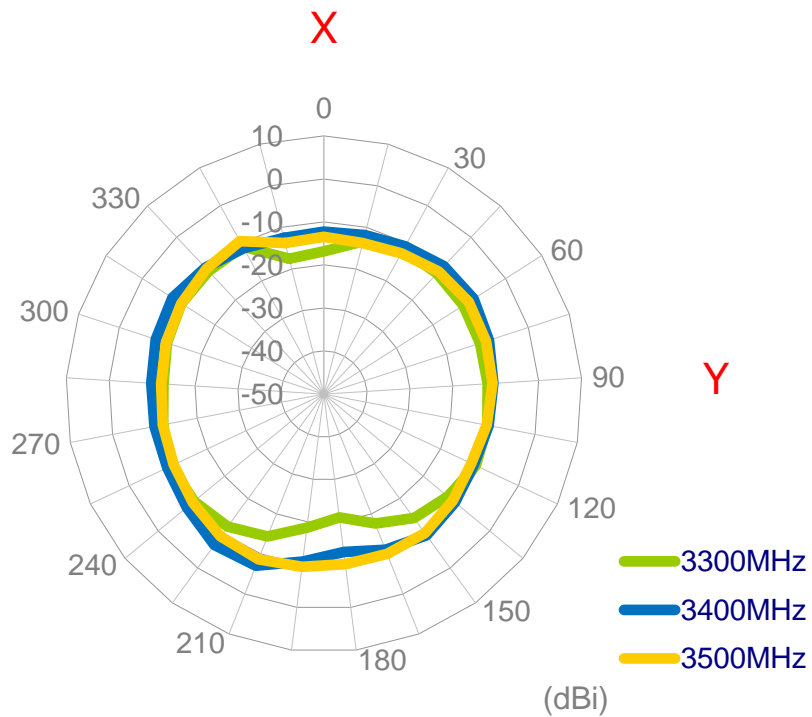
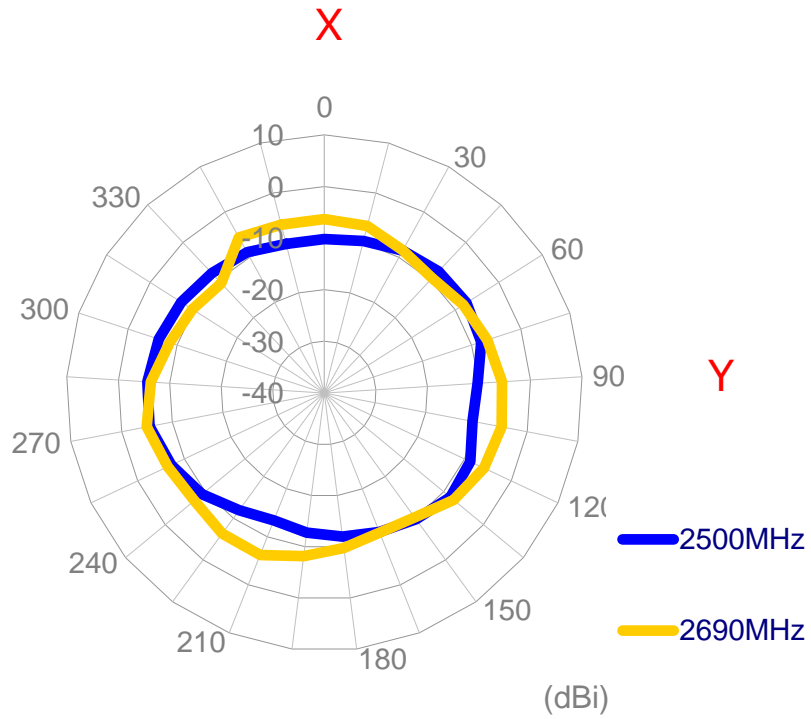

XZ Plane

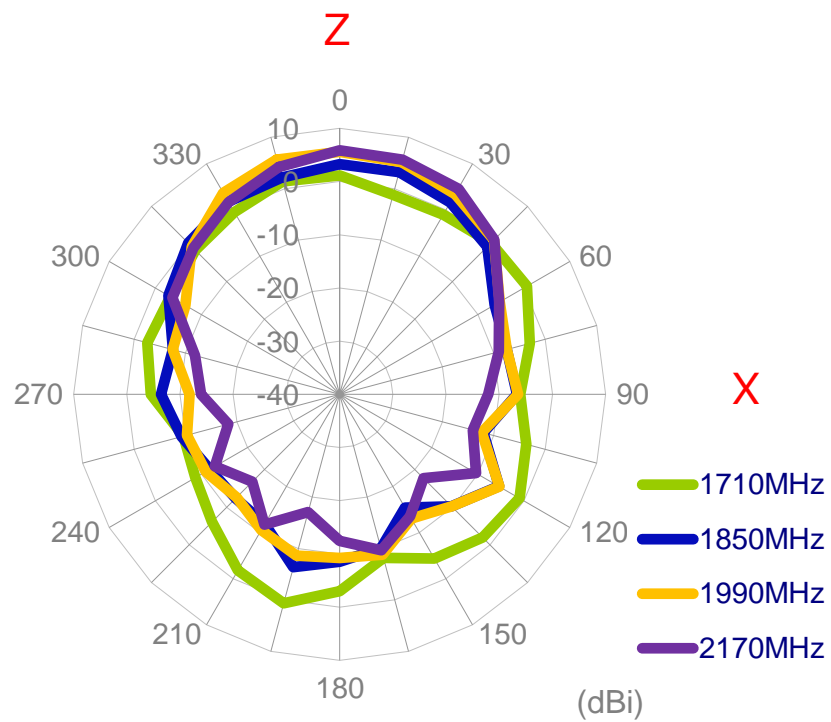
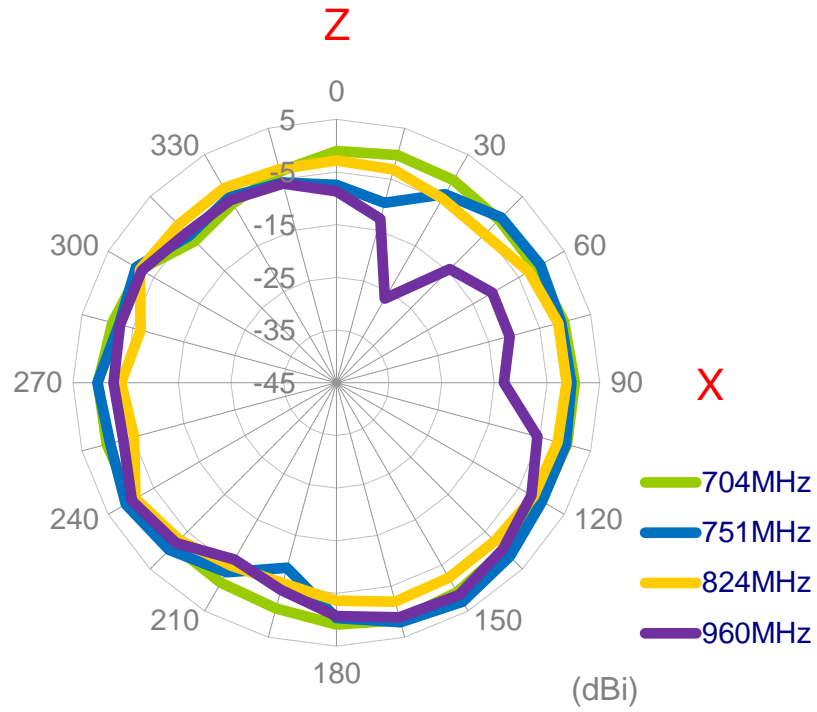

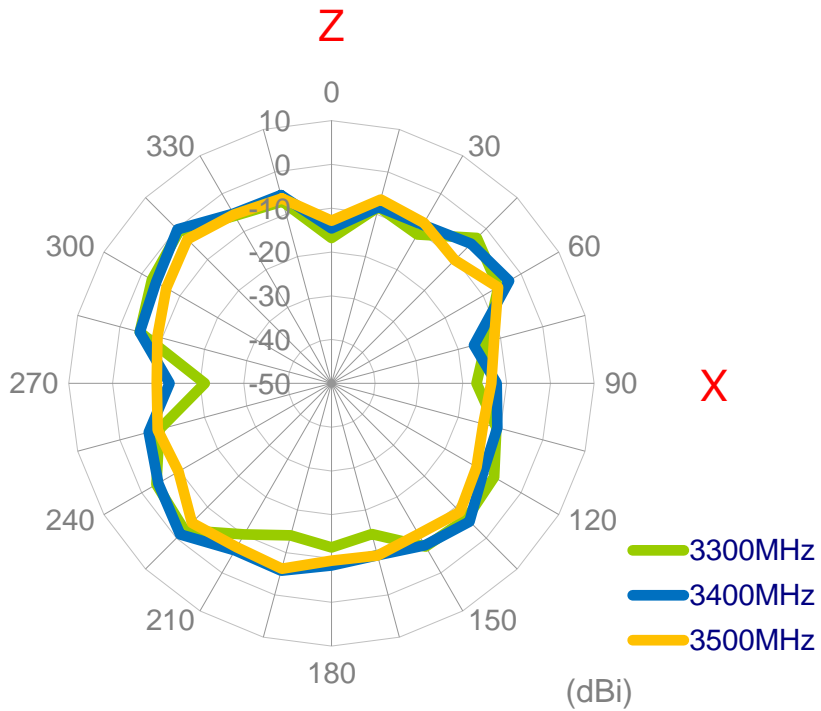
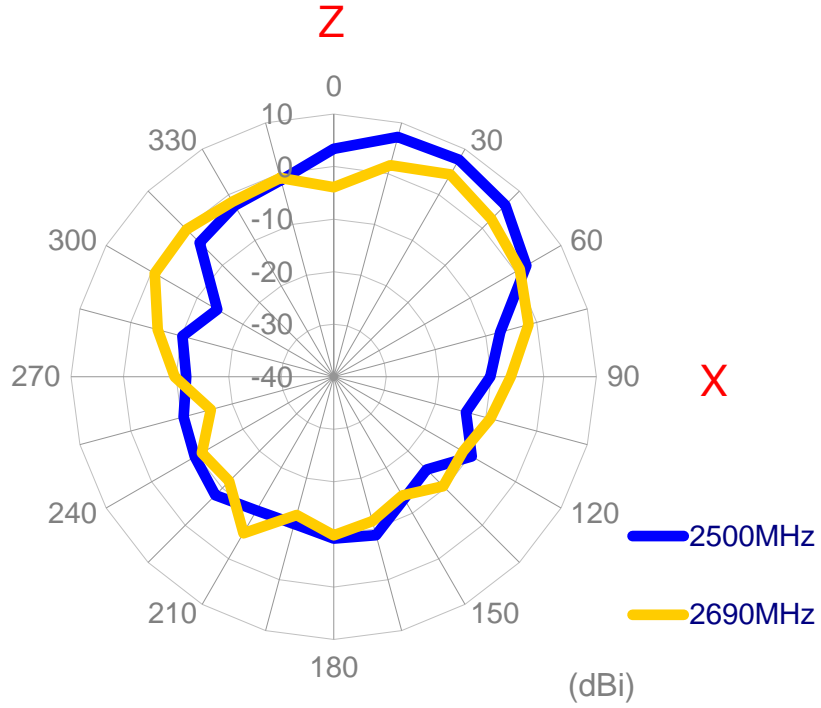

YZ Plane

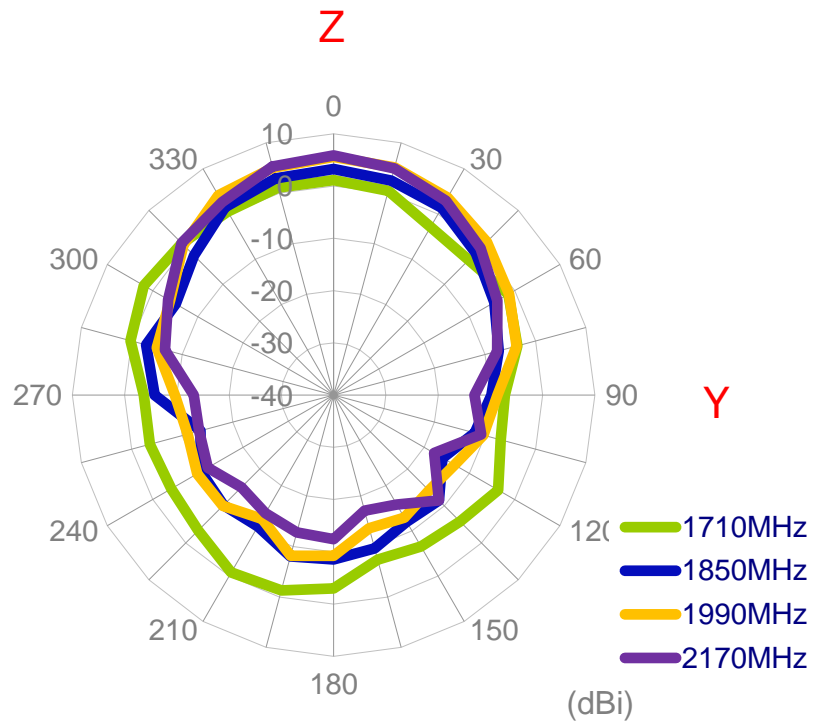
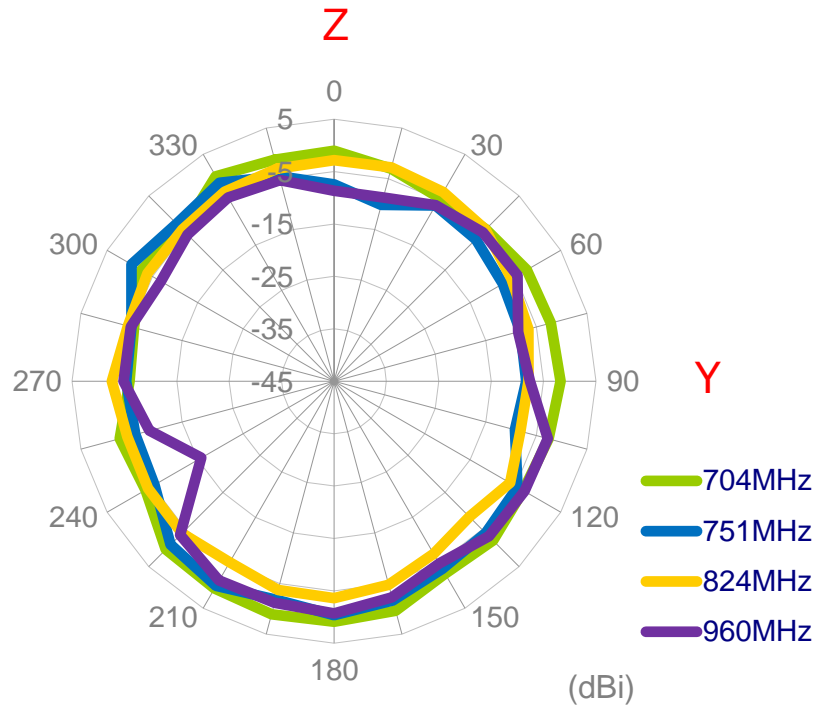

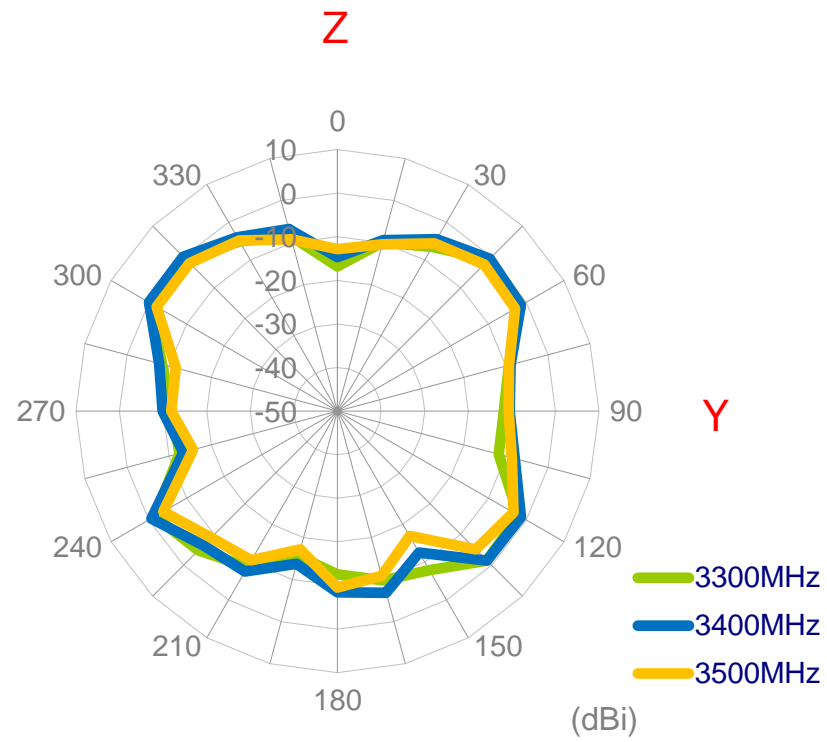
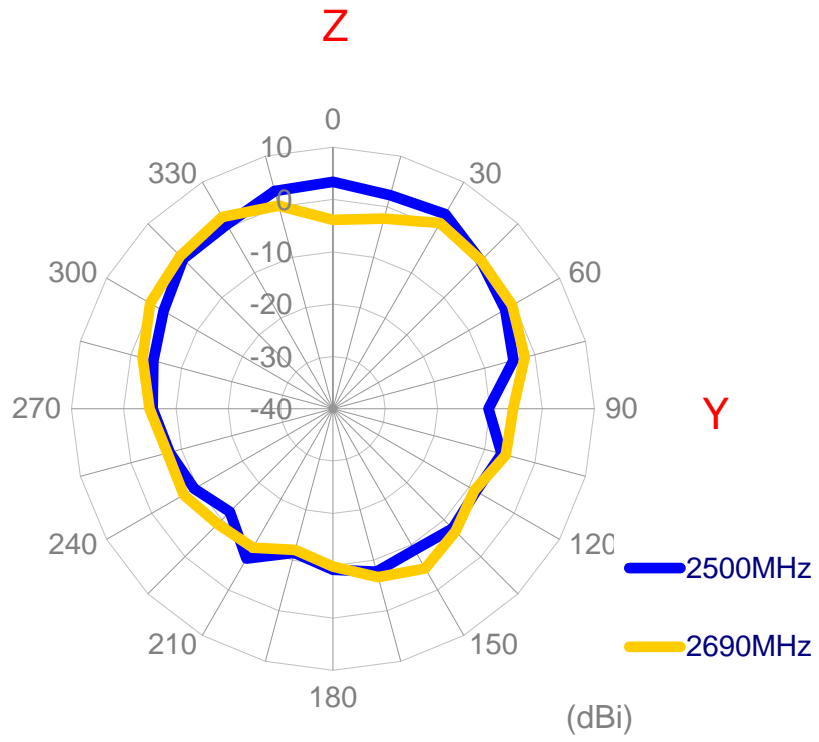

3.1.11 3D Radiation pattern (LTE with 1M cable length in free space)

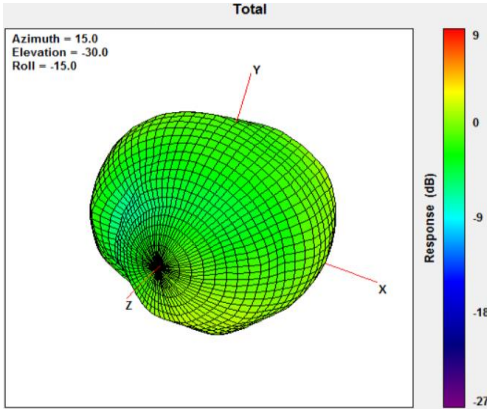

704MHz

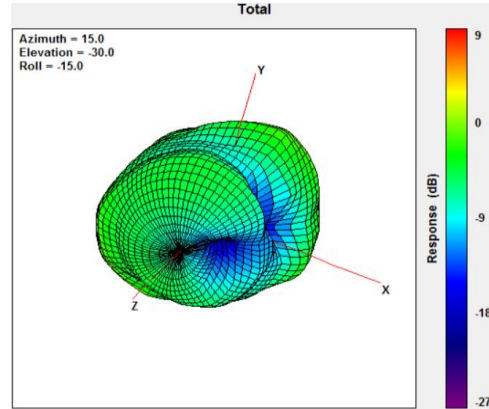

960MHz

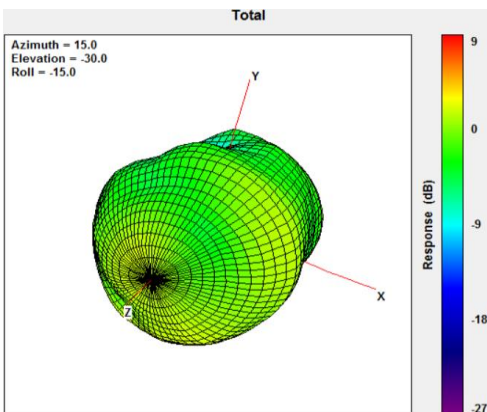

1710MHz

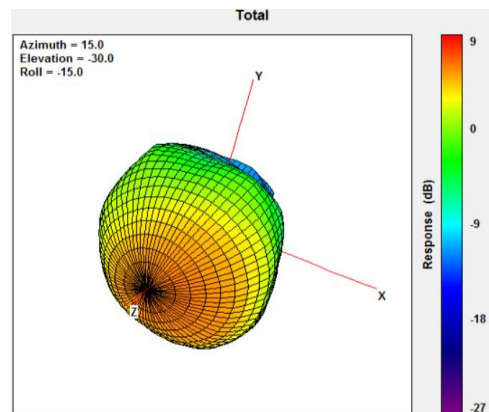

2170MHz

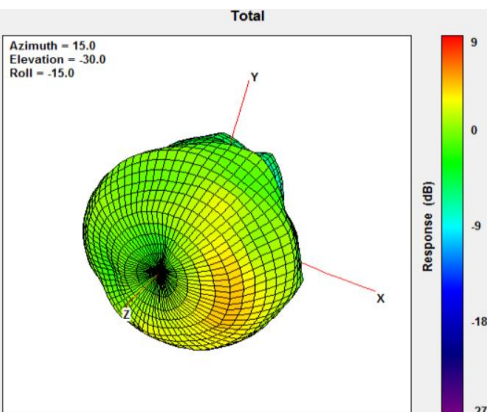

2690MHz

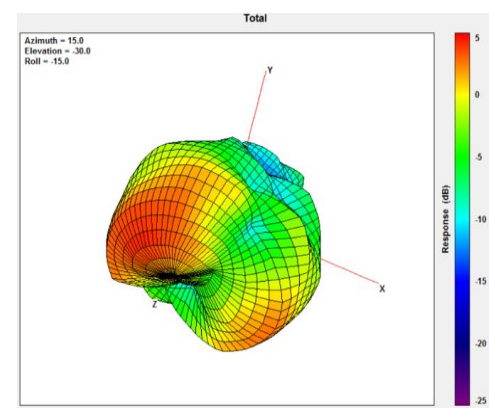

3500MHz

4. Mechanical Drawing (Unit: mm)

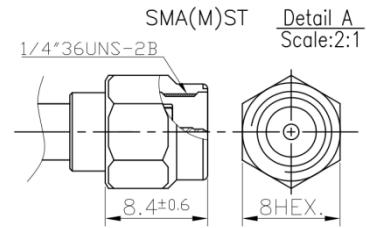
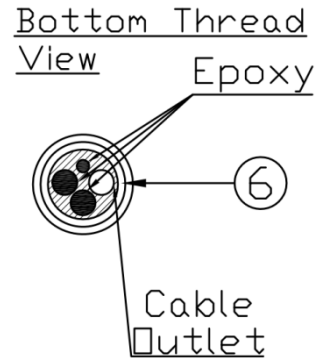
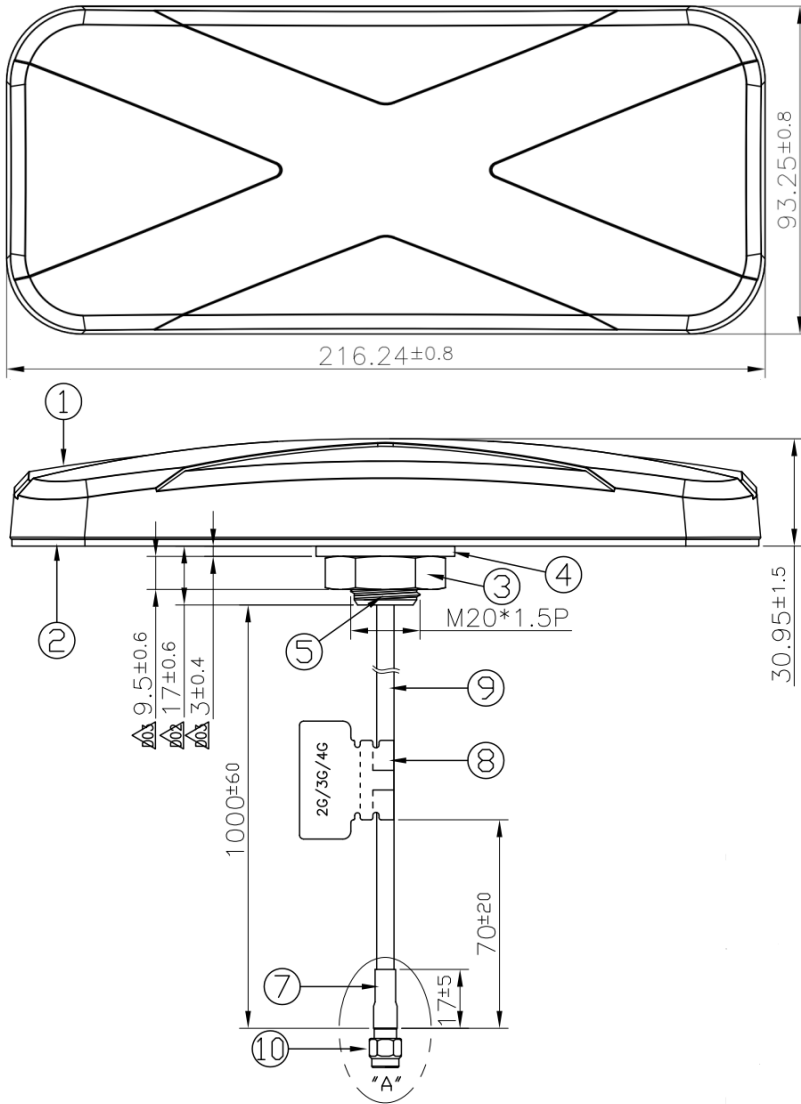

	Name	P/N	Material	Finish	QTY
1	Housing	000113K000066A	ABS+PC	Black	1
2	Closed Cell Foam	001013K000039A	3M 9448+CR-4305	Black	1
3	Nut_M20x1.5Px10H Cut	000413E030061A	Steel	Ni Plated	1
4	Washer_Cut	000413E040061A	Steel	Ni Plated	1
5	Metal Base	000313K000060A	AL	Ni Plated	1
6	Cable Rubber	000713E000063A	Silicone Rubber	Black	1
7	Heat Shrink Tube	001315C030000A	PE	Black	1
8	2G/3G/4G Label	001014C020051A	Coated Paper	White	1
9	CFD200 Coaxial Cable	301415C010000A	PVC	Black	1
10	SMA(M)ST	200211G010013A	Brass	Au Plated	1

5. Installation

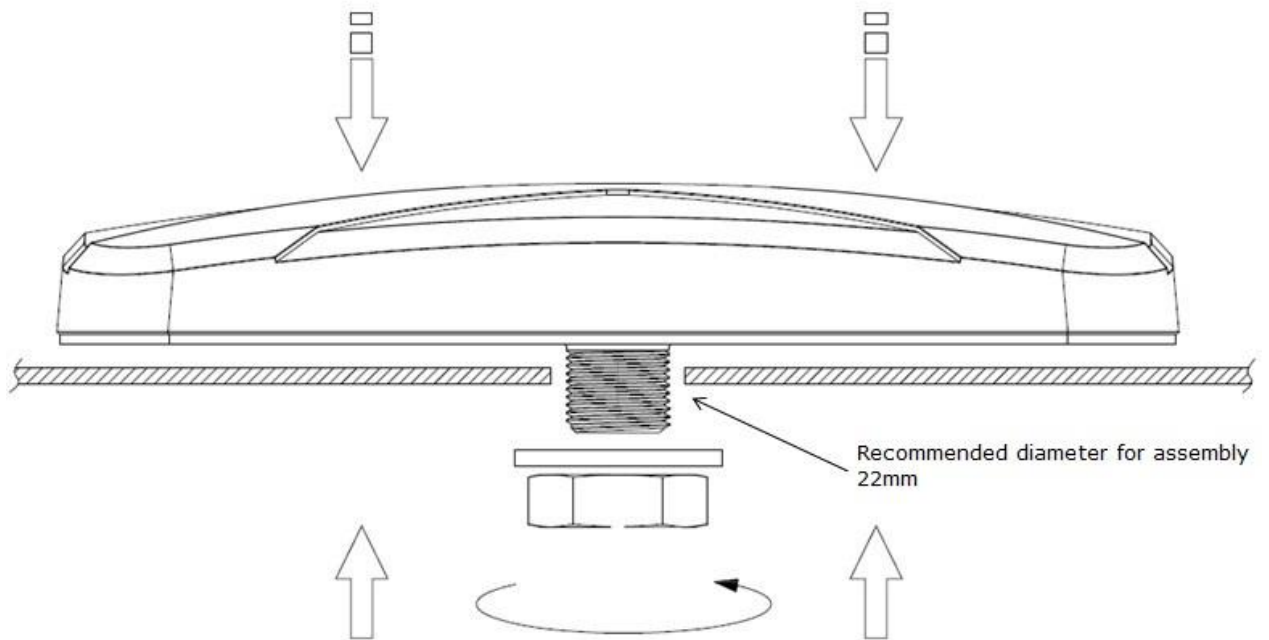

Recommended torque for mounting is 29.4 N.m
Maximum torque for mounting is 39.2 N.m

6. Packaging Spec

1pc MA413.A.B101111 per small box
 Box Dimensions - 325x125x106mm
 Weight - 630g

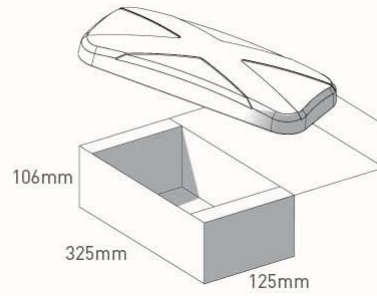

9 small boxes in one carton
 Carton Dimensions - 360x360x400mm
 Weight - 6.57Kg

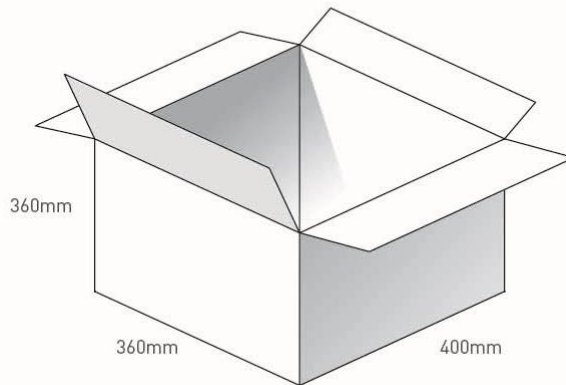

Pallet Dimensions 1080x720x1350mm
 15 Cartons per Pallet
 5 Cartons per layer
 3 Layers

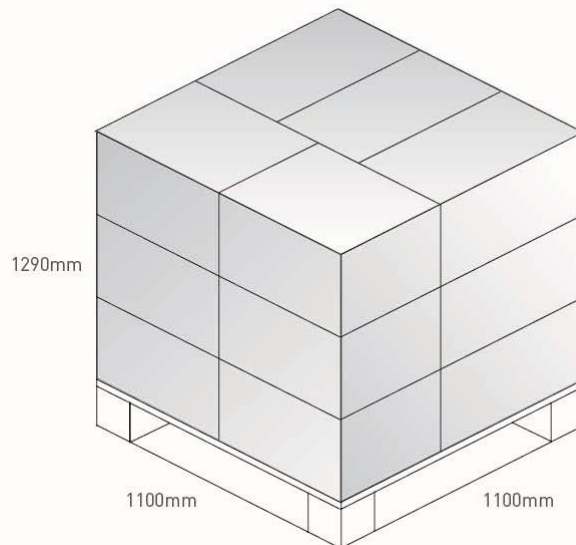

7. Application Note (LTE Antenna)

MA413 antenna performance with different cable lengths and different mounting environments is shown below.

7.1 On 50*50cm ground plane

7.1.1 Return Loss (MIMO_1 on the 50*50cm ground plane)

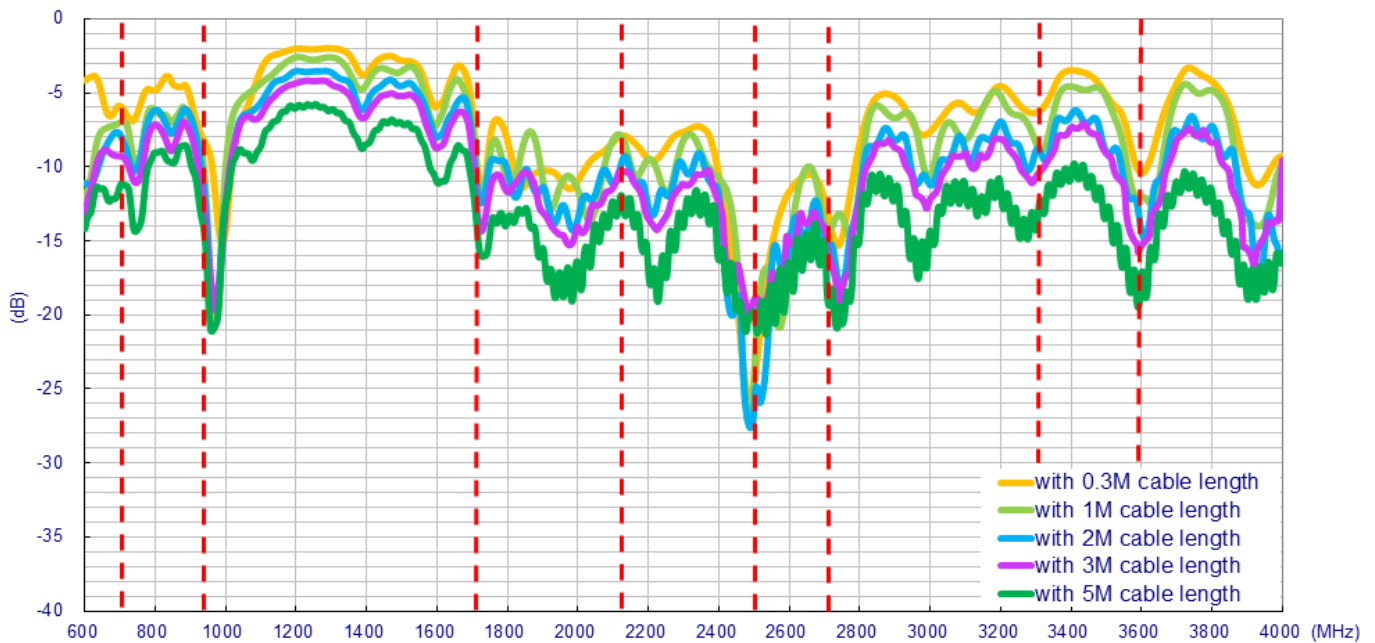

7.1.2 Efficiency (MIMO_1 on the 50*50cm ground plane)

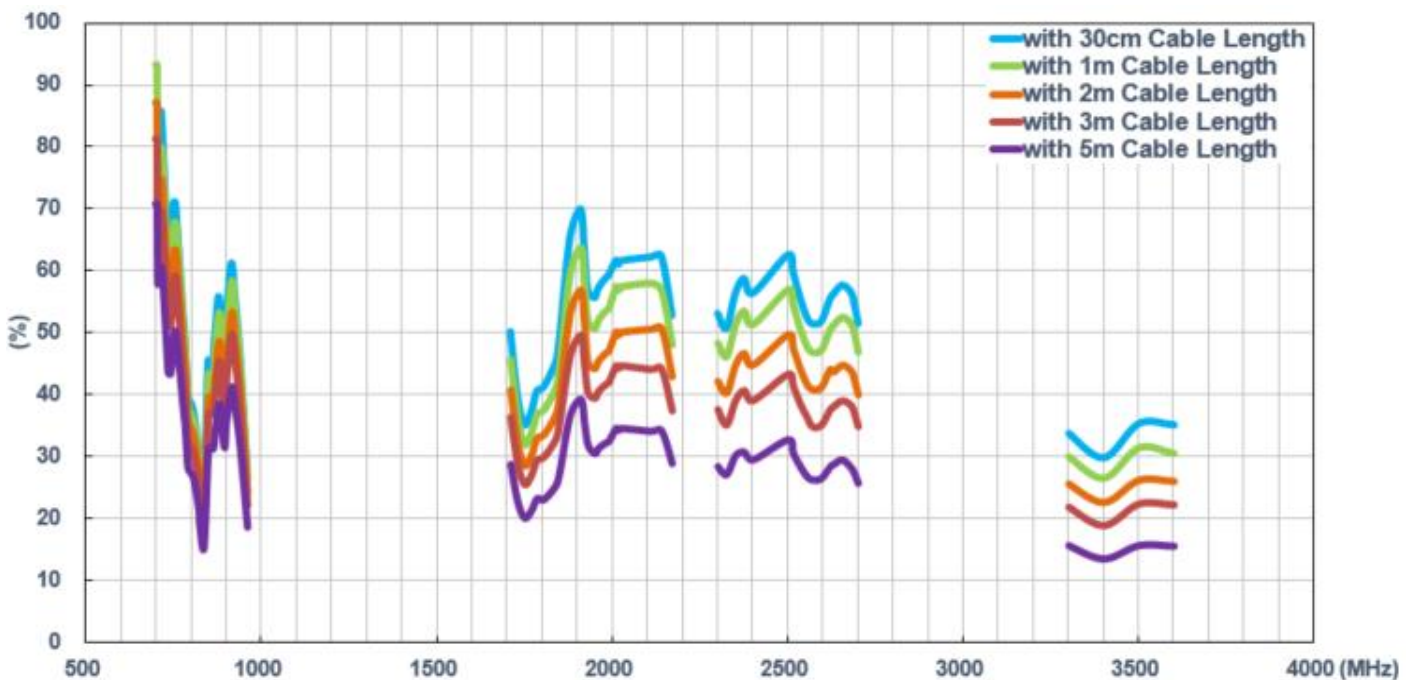

7.1.3 Average Gain (MIMO_1 on 50*50cm ground plane)

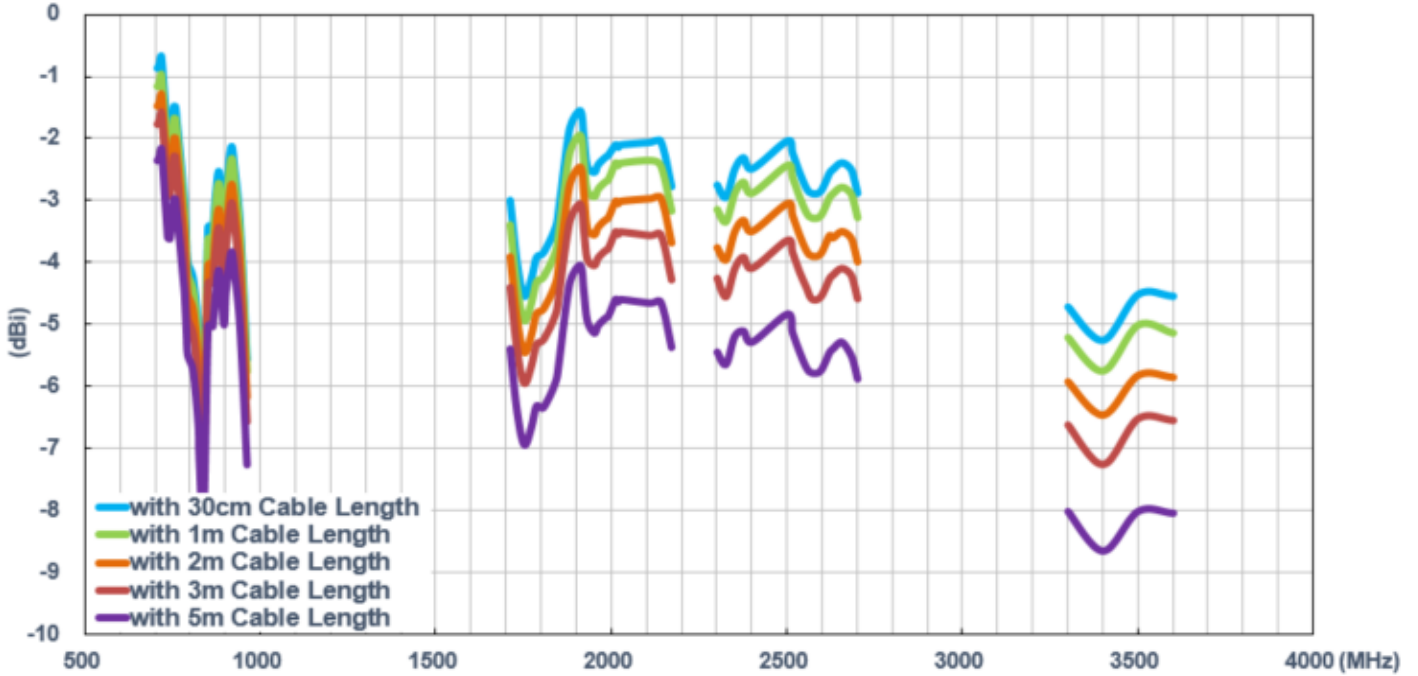

7.1.4 Peak Gain (MIMO_1 on 50*50cm ground plane)

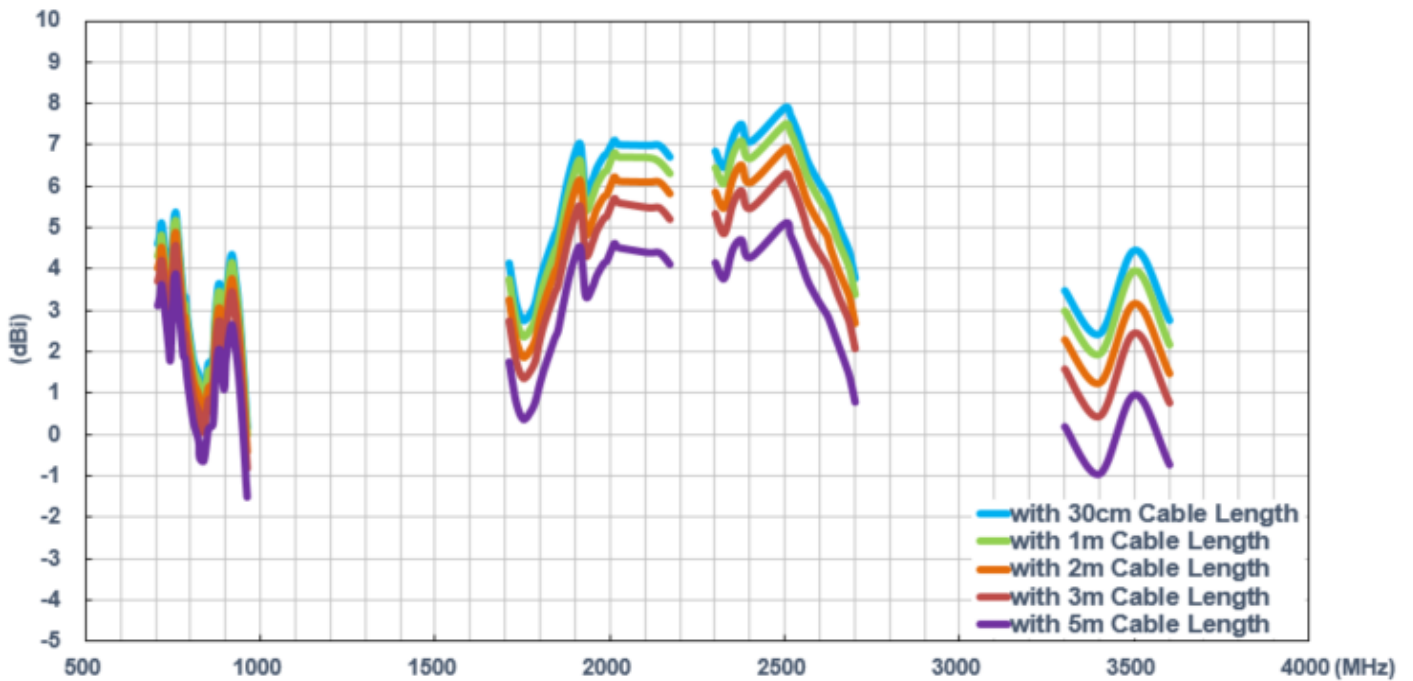

7.2 In free space

7.2.1 Return Loss (MIMO_1 in free space)

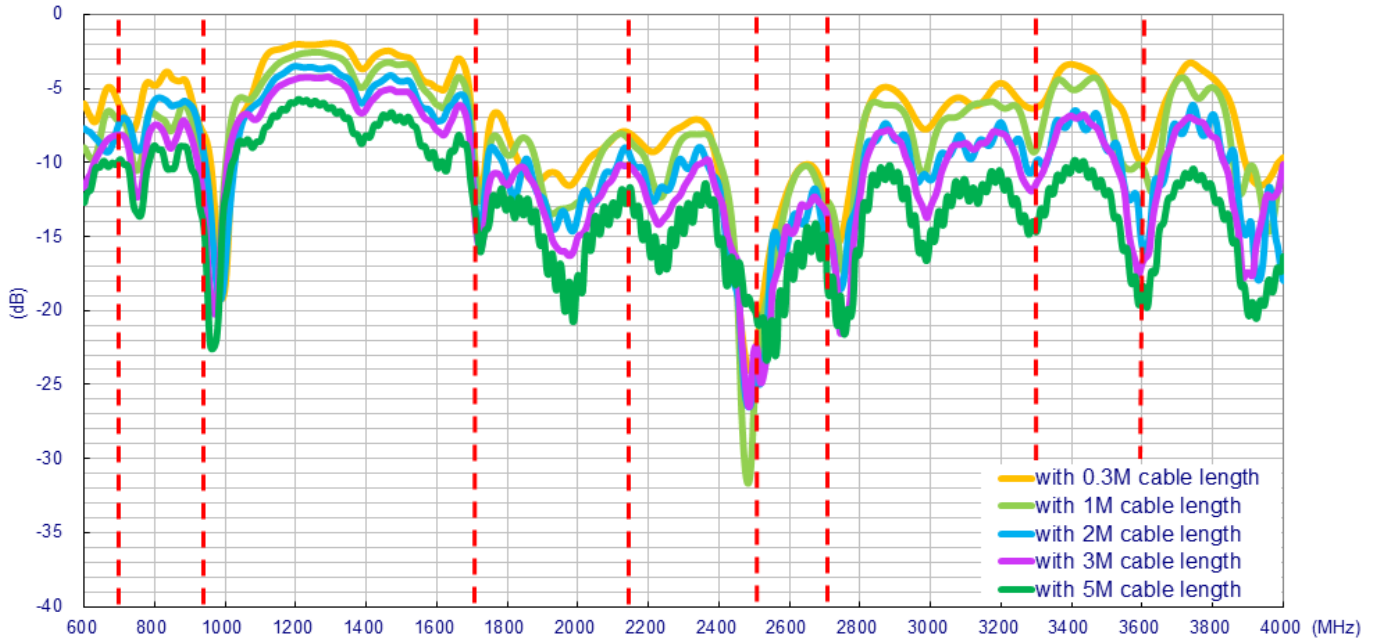

7.2.2 Efficiency (MIMO_1 in free space)

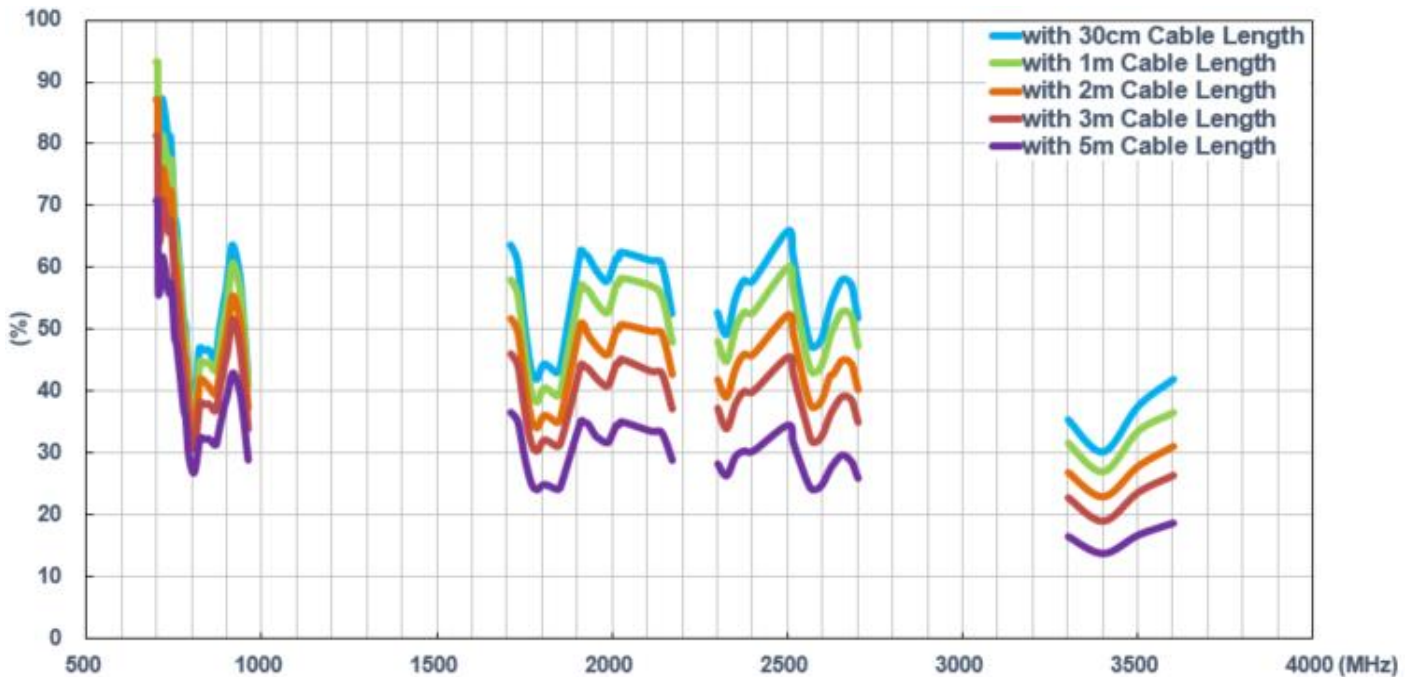

7.2.3 Average Gain (MIMO_1 in free space)

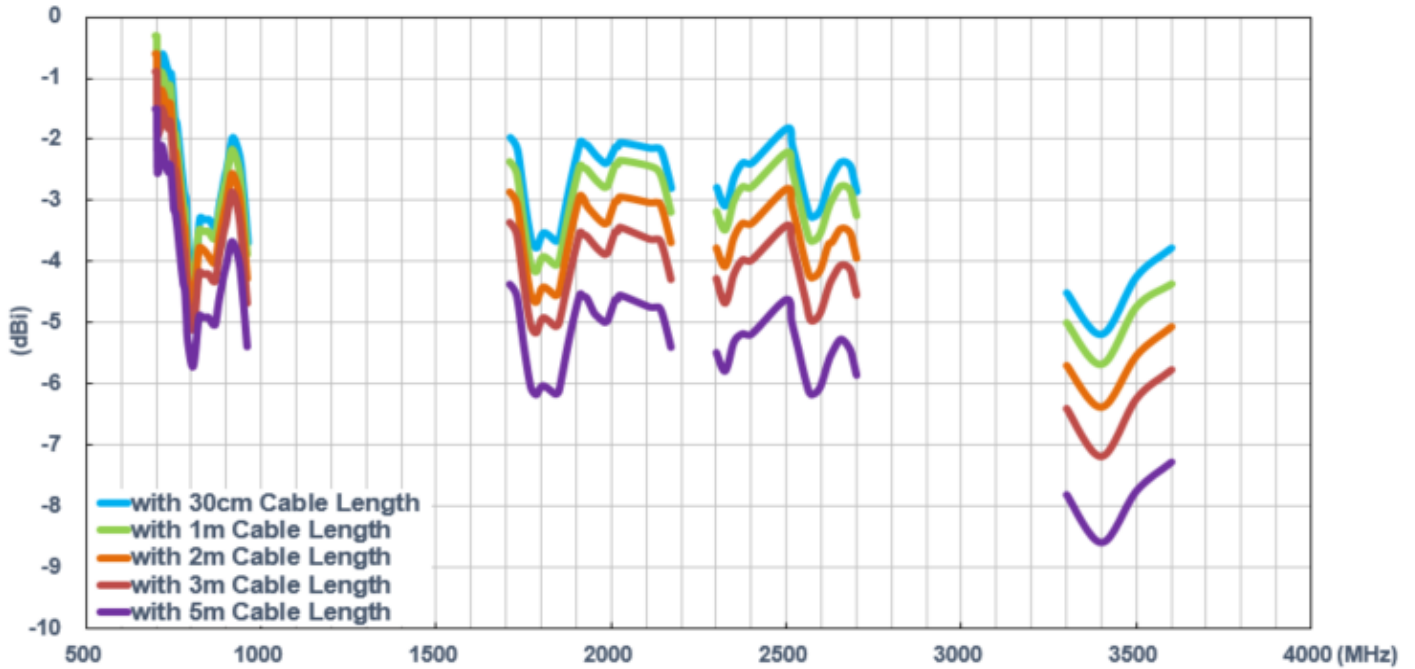

7.2.4 Peak Gain (MIMO_1 in free space)

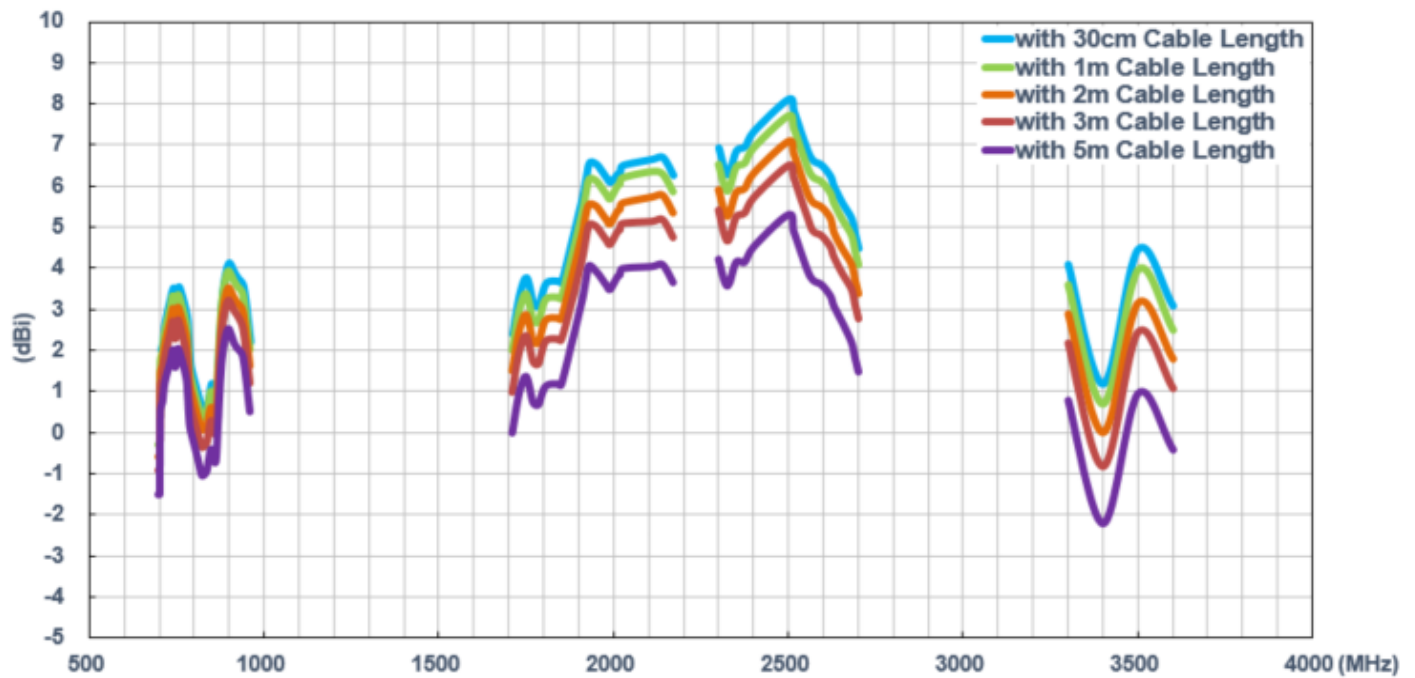



Taoglas makes no warranties based on the accuracy or completeness of the contents of this document and reserves the right to make changes to specifications and product descriptions at any time. Taoglas reserves all rights to this document and the information contained herein.

Reproduction, use or disclosure to third parties without express permission is strictly prohibited.

Copyright © Taoglas